

# LABORATORY EQUIPMENT

 **BOECO**  
Germany





# BALANCES

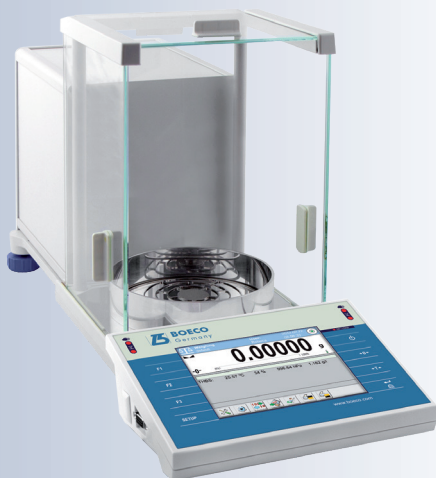

## BOECO BYY MODELS

Our professional premium Semi-Micro Analytical balances with internal calibration, 5,7" colour touch-screen, infrared proximity sensors, electronic level indicator, communication interfaces and data exchange through USB storage devices.

- ▶ Innovative 2-point adjustment system  
Brand new adjustment system guarantees the highest measurement accuracy. It minimizes linearity errors simultaneously providing reliable indications for the whole weighing range
- ▶ The best possible repeatability and USP regulations conformity  
The best weighing accuracy and repeatability - with  $sd \leq 1d$  combined with USP regulations conformity (Section 41 and 1251) make the BYY balances a new standard for mass measurement quality
- ▶ 21 CFR Part 11  
Support of 21 CFR Part 11 by weighing instruments software allows replacing paper documents with electronic ones. As a result of such operation the customer is offered coherent reliable and correct electronic documents and electronic signatures.

- ▶ Functions:  
Parts counting, checkweighing, dosing, weighing in percent, density determination (with optional kit), animal weighing, formulation, statistics, statistical quality control (SQC), differential weighing, pipettes calibration, GLP/GMP procedures, ambient condition monitoring

Menu navigation selectable in many languages

Specifiaction	BYY 21	BYY 22
Max. capacity	110 g	82 / 220 g
Minimal load	0,001 g	0,001 g
Readability	0,00001 g	0,00001 g 0,0001 g
Tare range	- 110 g	- 220 g
Repeatability	0,000012 g	0,000012 g
Linearity	$\pm 0,00006$ g	$\pm 0,00006$ g $\pm 0,0002$ g
Pan size	grid pan $\varnothing$ 90 mm	grid pan $\varnothing$ 90 mm
Stabilization time	4 sec.	4 sec.
Calibration	Internal (automatic)	
Interface	2 x RS 232 / 2 x USB / Ethernet / 4 digital In/Outputs / WIFI	
Display	5,7" colour touch-screen	
Working temperature	+10°C - +40°C	
Power Supply	110-230 V AC, 50/60 Hz	
Netweight / Grossweight	12,7 kgs / 16,4 kgs	
Size / Packing size	573x206x302 / 715x385x485 mm	

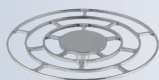

open work grid weighing pan

## BOECO BYY.A MODELS

- ▶ As the above BYY models but with touch-free operation:  
The BYY 21A and BYY 22A balances are equipped with motorized windshield doors operated by infrared sensors. This touch-free operation guarantees maximum comfort of operation and helps to keep the device clean.



Model	Readability	Capacity
BYY 21A	0,00001 g	110 g
BYY 22A	0,00001 g	82 g
(dual range)	0,0001 g	220 g

## BOECO BXX MODELS

Our new advanced level for Semi-Micro and Analytical balances with touch-screen and internal automatic calibration.

- ▶ 5" colour capacitive touch-screen / maximum comfort of operation
  - ▶ Personal display design allows using a wide selection of widgets
  - ▶ Multilingual, interactive menu
  - ▶ Built-in IR sensors allow numerous operations (touch-free operations)
  - ▶ Conformity with GLP and GMP regulations
  - ▶ Dynamically controlled sample weight (bar graph)
  - ▶ Statistics, formulations, reports and printouts
  - ▶ Alibi memory with record of measurements
  - ▶ Complex databases
- ▶ Functions: autotest, dosing, percent weighing, parts counting, peak hold, formulation, newton unit measurement, statistics, checkweighing, infrared sensors, under hook weighing, GLP procedures, animal weighing, air density correction, density determination, ambient conditions, replaceable unit, alibi memory, mass for titrator

Menu navigation selectable in many languages

Specifiaction	BXX 22	BXX 30	BXX 31
Max. capacity	82 /220 g	310 g	220 g
Minimal load	0,001 g	0,01 g	0,01 g
Readability	0,00001/0,0001 g	0,0001 g	0,0001 g
Tare range	- 220 g	- 310 g	- 220 g
Repeatability	0,000015/0,0001 g	0,0001 g	0,0001 g
Linearity	± 0,00006/0,0002 g	± 0,0003 g	± 0,0002 g
Pan size	Open work pan ø 90 mm	ø 100 mm	ø 100 mm
Stabilization time	6 / 3,5 sec.	3,5 sec.	3,5 sec.
Calibration	Internal (automatic)		
Interface	2 x RS232, 2 x USB (A+B), WIFI		
Display	5" colour capacitive touch-screen		
Working temperature	+10°C - +40°C		
Power Supply	110-230 V AC, 50/60 Hz		
Netweight / Grossweight	5,4 kgs / 9 kgs		
Size / Packing size	333x206x355 / 550x460x580 mm		

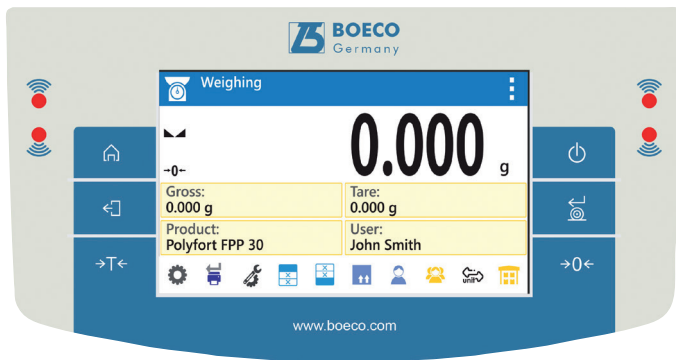

Our new advanced level touch-screen Precision balances with internal calibration.

Specifiaction	BXX 40	BXX 51
Max. capacity	750 g	4500 g
Minimal load	0,02 g	0,5 g
Readability	0,001 g	0,01 g
Tare range	- 750 g	- 4500 g
Repeatability	0,015 g	0,01 g
Linearity	± 0,003 g	± 0,02 g
Pan size	128 x 128 mm	195 x 195 mm
Stabilization time	2 sec.	1,5 sec.
Calibration	Internal (automatic)	
Interface	2 x RS232, 2 x USB (A+B), WIFI	
Display	5" colour capacitive touch-screen	
Working temperature	+10°C - +40°C	
Power Supply	110-230 V AC, 50/60 Hz	
Netweight / Grossweight	3,5 / 7,1 kgs	3,6 / 7,2 kgs
Size / Packing size	333x206x100/170 / 530x440x410 mm	

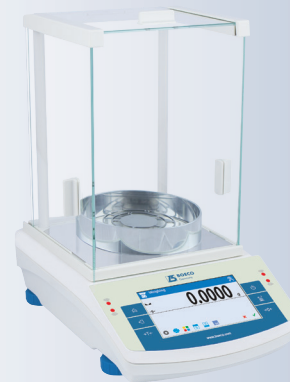

Model	Readability	Capacity
BXX 22	0,00001 g	82 g
(dual range)	0,0001 g	220 g



Model	Readability	Capacity
BXX 30	0,0001 g	310 g
BXX 31	0,0001 g	220 g

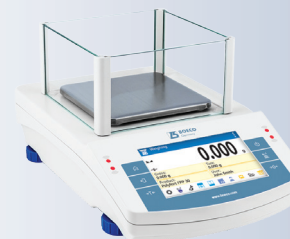

Model	Readability	Capacity
BXX 40	0,001 g	750 g



Model	Readability	Capacity
BXX 51	0,01 g	4500 g

## BOECO BAS PLUS MODELS

Our Standard Analytical balances with automatic internal calibration

The Plus Version with: Display with enlarged characters, keypad with quick access buttons, communication interfaces 2 x USB (1 x to work with printers with PCL protocol) (and optional WIFI)

► Functions: autotest, dosing, percent weighing, totalizing, parts counting, peak hold, Newton unit measurement, statistics, checkweighing, under hook weighing, GLP procedures, animal weighing, pipettes calibration, density determination.

Menu navigation selectable in many languages

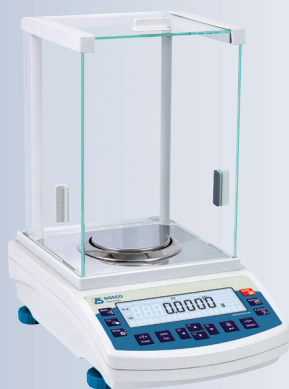

Specification	BAS 31 plus	BAS 32 plus
Max. capacity	220 g	110 g
Minimal load	0,01g	0,01g
Readability	0,0001 g	0,0001 g
Tare range	- 220 g	- 110 g
Repeatability	0,0001 g	0,0001 g
Linearity	± 0,0002 g	± 0,0002 g
Pan size	∅ 100 mm	∅ 100 mm
Stabilization time	3,5 sec.	3,5 sec.
Calibration	Internal (automatic)	
Interface	2xRS232, 2xUSB(A+B), WIFI (optional)	
Display	large LCD with backlight	
Working temperature	+10°C - +40°C	
Power Supply	110-230 V AC, 50/60 Hz	
Netweight / Grossweight	5,6 kgs / 9,5 kgs	
Size / Packing size	333x206x355 / 550x460x580 mm	

**Both BASplus balances are available in an optional WIFI interface version**

## BOECO BPS PLUS MODELS

Our Standard Precision balances with automatic internal calibration

The Plus Version with: Display with enlarged characters, keypad with quick access buttons, communication interfaces 2 x USB (1 x to work with printers with PCL protocol) and optional WIFI.

► Functions: autotest, dosing, percent weighing, totalizing, parts counting, peak hold, Newton unit measurement, statistics, checkweighing, under hook weighing, GLP procedures, animal weighing, density determination

Menu navigation selectable in many languages

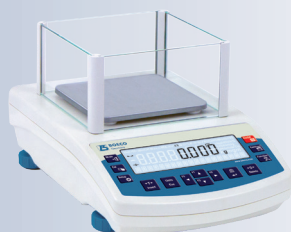

Specification	BPS 40 plus	BPS 41 plus	BPS 51 plus	BPS 52 plus
Max. capacity	750 g	360 g	4500 g	2100 g
Minimal load	0,02 g	0,02 g	0,5 g	0,5 g
Readability	0,001 g	0,001 g	0,01 g	0,01 g
Tare range	- 750 g	- 360 g	- 4500 g	- 2100 g
Repeatability	0,015 g	0,001 g	0,01 g	0,01 g
Linearity	± 0,003 g	± 0,002 g	± 0,02 g	± 0,02 g
Pan size	128 x 128 mm		195 x 195 mm	
Stabilization time	2 sec.		1,5 sec.	
Calibration	Internal (automatic)			
Interface	2xRS232, 2xUSB (A+B), WIFI (optional)			
Display	large LCD with backlight			
Working temperature	+10°C - +40°C			
Power Supply	110-230 V AC, 50/60 Hz			
Netweight / Grossweight	4,3 / 6,3 kgs		4,8 / 6,3 kgs	
Size / Packing size	333x206x100/170 / 530x440x420 mm			

**All 4 BPSplus balances are available in an optional WIFI interface version**

Model	Readability	Capacity
BAS 31 plus	0,0001 g	220 g
BAS 32 plus	0,0001 g	110 g

Model	Readability	Capacity
BPS 40 plus	0,001 g	750 g
BPS 41 plus	0,001 g	360 g



Model	Readability	Capacity
BPS 51 plus	0,01 g	4500 g
BPS 52 plus	0,01 g	2100 g



## BOECO BWL MODELS

Our Basic Precision balances with external calibration and internal rechargeable accu with power charger. This makes them independent from a mains supply and therefore portable.

### ► Functions:

Parts counting, weighing in percent, totalising, checking, under hook weighing, animal weighing, GLP procedures, measurement in Newton.

Specifiacion	BWL 51	BWL 61	BWL 60
Max. capacity	2000 g	6000 g	10 kg
Readability	0,01 g	0,1 g	0,1 g
Tare range	- 2000 g	- 6000 g	- 10 kg
Repeatability	0,03 g	0,3 g	0,1 g
Linearity	± 0,03 g	± 0,3 g	± 0,1 g
Pan size	195 x 195 mm		
Stabilization time	3 sec.		
Calibration	external		
Interface	RS 232		
Display	LCD with backlight		
Working temperature	+15°C - +30°C		
IP rating	IP 43		
Power Supply	110-230 V AC, 50/60 Hz		
Operation time on batteries	45 hours (average time)		
Netweight / Grossweight	2,8 kgs / 4,3 kgs		
Size / Packing size	335x210x88 / 470x380x336 mm		



Model	Readability	Capacity
BWL 51	0,01 g	2000 g
BWL 61	0,1 g	6000 g
BWL 60	0,1 g	10 kg

## CALIBRATION WEIGHTS

cylindrical shape, nickel-plated and polished brass, packed in a lined plastic container, with DAKkS certificate

Code	Description
BOE F1-2000	Calibration weight, 2 kg, F1
BOE F1-5000	Calibration weight, 5 kg, F1
BOE F1-10000	Calibration weight, 10 kg, F1



## BOECO BLC MODELS

Our range of low-cost balances, an alternative for most basic weighing applications.

### ► Functions:

Simple three-key operation, Large weighing pan, Energy saving mode, Usable with single 9V battery or power supply.

Multiple weigh units: Choose from: grams, ounces, pounds/ounces, pennyweight or Troy ounces, Parts counting application.

The BLC 220 is supplied with a plastic windshield and an AC adaptor

The BLC 1500/BLC 3000 are supplied without battery and AC adaptor

Specifiacion	BLC 220	BLC 1500	BLC 3000
Max. capacity	220 g	1500 g	3000 g
Readability	0,01 g	0,1 g	1 g
Tare range	0-220 g	0-1500 g	0-3000 g
Repeatability	± 0,02 g	± 0,1 g	± 1 g
Linearity	± 0,02 g	± 0,1 g	± 1 g
Pan size	∅ 110 mm	138 x 134 mm	
Stabilization time	4 sec.	2 sec.	
Calibration	external		
Display	LCD with LED backlight		
Working temperature	+10°C - +35°C		
Power Supply	9V/100mA battery /AC adaptor		
Netweight / Grossweight	458 g / 390 g		
Size	190x140x63 / 190x140x45 mm		

Code	Description
BOE 138134	Stainless steel platform for BLC 1500 / 3000



Model	Readability	Capacity
BLC 220	0,01 g	220 g



optional st. steel platform

Model	Readability	Capacity
BLC 1500	0,1 g	1500 g
BLC 3000	1 g	3000 g

## BOECO MOISTURE ANALYZER BMA H50, BMA I50

► Functions: drying modes, samples drying, water vapor permeability, halogen, humidity analysis, dry mass determination, elevated temperature level, GLP/GMP procedures.



Specification	BMA H50	BMA I50
Heating Module	<b>Halogen emitter</b>	<b>Infrared emitter</b>
Range of Drying temp	<b>250°C</b>	<b>160°C</b>
Max. capacity		50 g
Readability		0,001 g
Tare range		- 50 g
Max mass sampling		50 g
Accuracy of moisture reading		0,001 %
Repeatability		±0,05 % (sample < 2 g) ±0,01 % (sample >10 g)
Max. height of tested sample		h = 20 mm
Pan size		ø 90 mm, h = 8 mm
Drying modes	4 drying modes (standard, quick, step, mild)	
Auto switch off options	4 options (manual, automatic, time defined, user-defined)	
Additional functions	sample identification	
Power of heating device	400 W	
Interface	1xRS232, 2xUSB (A+B), WIFI (optional)	
Display	LCD with backlight	
Working temperature	+10°C - +40°C	
Power Supply	110-240 V AC, 50/60 Hz	
Netweight / Grossweight	4,9 kgs / 6,4 kgs	
Size / Packing size	333x206x190 / 470x380x336 mm	

## BOECO MOISTURE ANALYZER BMX H50, BMX I50

as the above models BMA H50 and BMA I50 but with

- LCD 5" capacitive colour touch-screen
- The drying chamber can be opened and closed automatically using button or proximity sensors.
- SMART DRY - prognosis of the Drying Process Result. It is an option dedicated for users who require fast and multiple estimation of the materials moisture content. SMART DRY method is a prognosis of the end result carried out before the drying process is completed.



Specification	BMX H50	BMX I50
Heating Module	<b>Halogen emitter</b>	<b>Infrared emitter</b>
Range of Drying temp	<b>250°C</b>	<b>160°C</b>
Max. capacity		50 g
Readability		0,001 g
Tare range		- 50 g
Max mass sampling		50 g
Accuracy of moisture reading		0,001 %
Repeatability		±0,05 % (sample 2 g) ±0,01 % (sample 10 g)
Max. height of tested sample		h = 20 mm
Pan size		ø 90 mm, h = 8 mm
Drying modes	4 drying modes (standard, quick, step, mild)	
Auto switch off options	4 options (manual, automatic, time defined, and user-defined)	
Additional functions	sample identification	
Power of heating device	400 W	
Interface	1xRS232, 2xUSB (A+B), WIFI	
Proximity sensors	2	
Display	LCD 5" capacitive colour touch-screen	
Working temperature	+10°C - +40°C	
Power Supply	110-240 V AC, 50/60 Hz	
Netweight / Grossweight	5,2 kgs / 6,7 kgs	
Size / Packing size	333x206x190 / 595x395x420 mm	



## ACCESSORIES FOR BMA/BMX MOISTURE ANALYZERS

Code	Description
BOE PAN90	Aluminium sample pans, round, $\varnothing = 90$ mm (box of 50)
BOE 440017	Glass fiber filters MG 161, 90 mm $\varnothing$ , with binder, anorganic, 75 g/m <sup>2</sup> (box of 50)
BOE F1-50	Calibration weight, 50 g, F1, cylindrical shape. nickel-plated and polished brass, packed in a lined plastic container, with DAkkS certificate

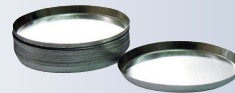

## PRINTER FOR BOECO BALANCES

Code	Description
BOE TMU220D	Epson TM-U 220D dot-matrix printer
BOE P0151	Cable to connect the printer TM-U-220D with the BOECO balances with RS232 interface



Code	Description
BOE TMT20II	Epson TM-T20II thermal printer, incl. USB printer cable (type A to B)



## ACCESSORIES

Code	Description
BOE KIT 85	Density determination KIT for solids and liquids, for balances featuring weighing pan $\varnothing$ 85, 90 and 100 mm
BOE KIT 128	Density determination KIT for balances with weighing pan 128 x 128 mm
BOE KIT 195	Density determination KIT for balances with weighing pan 195 x 195 mm
BOE WINPC	BOECOWIN PC Software, for collecting measurement data and performing some statistical calculations. <b>Free downloadable at <a href="http://www.boeco.com">www.boeco.com</a></b>
BOE P0108	RS 232 cable (balance-computer)
BOE USBAB	USB cable Typ A to B (balance-computer)
BOE DC-1	Dust cover for BAS / BXX analytical balances
BOE DC-2	Dust cover for BPS 51 / BPS 52 PLUS, BXX 51 and BWL 51 / BWL 60 / BWL 61 balances

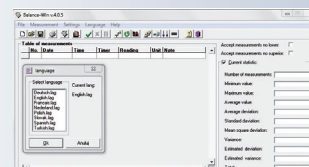

# SPECTROPHOTOMETERS

## BOECO SPECTROPHOTOMETER MODELS S-200 VIS & S-220 UV/VIS

The BOECO S-220 (UV/VIS) and S-200 (VIS) are high quality, compact, low cost measurement systems for daily analysis in education, QC and basic research.

### ► Compact single beam optics with full range scanning

The single beam optics are compact and bench space saving. The long life Hamamatsu Xenon lamp optics in the S-220 ensure quick and reliable performance and the Tungsten Halogen lamp used in S-200 also provide a reliable measurement.

### ► Color touch screen operation

The intuitive color touch screen operation provides simple access to an extensive range of functions. The touch screen is sensitive to stylus and laboratory gloves. Icon driven on-board software improves accessibility and the graphical display allows spectrum or standard curve to be shown on the screen. The forward and back quick key allows the user to proceed or swiftly return to the process. An enlarged data display for photometry measurement makes result reading easier.

### ► Various measurement modes

Operation modes include photometric, multiple wavelength analysis, spectrum scanning, time scan and kinetics; direct concentration results are included.

### ► Optional accessories

A variety of accessories are included such as test tube holder, flow cell with sipper, temperature control holder, long path length cuvette holder & multiple cell holder are available to enhance different application needs.

### ► Storage and data output

External storage with SD card and free downloadable PC Software MasterReport ([www.boeco.com](http://www.boeco.com)) allows data export to PC in compatible text or spreadsheet format for further data processing in the PC. Method and result storage is almost unlimited by exchanging SD card when needed. Printer options are available for direct result printing with graphics.

### ► Validation function

To ensure optimum instrument performance, self diagnosis functions are equipped in GLP/GMP feature for performance validation and auditing.



S-200  
S-220

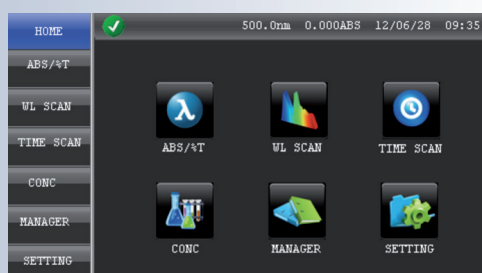

MAIN MENU

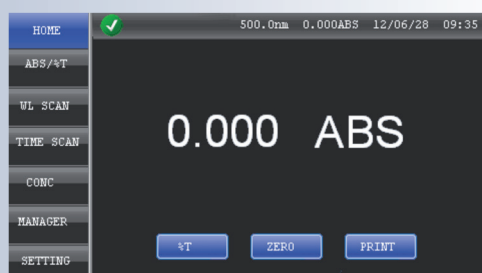

LARGE DISPLAY MEASURE

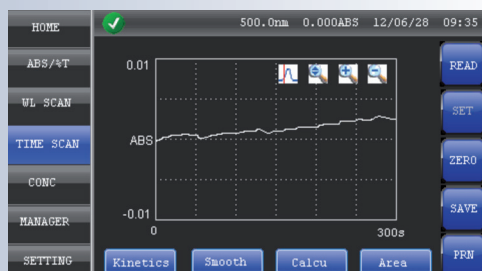

TIME SCAN RESULTS AND DATA PROCESSING

Code	Description
BOE 8620000	Model S-200 Vis Spectrophotometer, single beam with full range scanning and color touch screen operation. Supplied with 10 x 10 mm cuvette holder
BOE 8622000	Model S-220 UV/Vis Spectrophotometer, single beam with full range scanning and color touch screen operation. Supplied with 10 x 10 mm cuvette holder



**Specification**

**S-200 Vis**

**S-220 UV/Vis**

Wavelength Range:	320 to 1100nm	190 to 1000nm
Spectral Bandwidth:	6nm	5nm
Transmittance accuracy:	±0,5% T (NIST 930 Filter)	±1% T (NIST 930 Filter)
Transmittance repeatability:	0.2% T	0.5% T
Baseline flatness:	± 0.002 Abs (330-1090nm)	± 0.005 Abs (200-990nm)
Noise level:	≤ 0.001 Abs (500nm)	≤ 0.005 Abs (250 nm)
Baseline stability:	≤ 0.001 Abs/h (500nm) (after 2 hours warm up)	≤ 0.005 Abs/h (250nm) (after 2 hours warm up)
Stray light:	≤ 0.5% T	≤ 0.5% T
Wavelength controlled variable:	0.2nm	0,2nm
Wavelength accuracy:	± 1nm	± 2nm
Wavelength repeatability:	≤ 0,5nm	≤ 1nm
Wavelength scan speed:	2400nm/min (0,2 sampling interval without filter)	300nm/min (0,2 sampling interval without filter)
Wavelength move speed:	to any specified position within 1sec.	to any specified position within 1sec.
Absorbance:	-0.3 to 1.999	-0.3 to 1.999
Transmittance:	0 to 199.9%	0 to 199.9%
Spectrum Scanning:	Yes	Yes
Concentration:	-300 to 1999	-300 to 1999
Selectable Resolution:	1, 0.1, 0.01 or 0.001	1, 0.1, 0.01 or 0.001
Light source:	Tungsten Halogen lamp	pulsed-Xenon lamp
Detector:		Silicon photodiode
Display screen:		4,3 inches colorful touch LCD screen
Printer:		specified 80-column thermal printer (series port)
Metering mode:		Single beam
Memory:		SD card storage
Time Scan:		Graphical and calculated concentration value
Analysis:		Absorbance and wavelength of peaks and valleys
GLP:		Real time clock and calendar, Self Diagnosis
Size:		400 (W) x 280 (D) x 160 (H) mm
Power requirement:		AC, 100-240V, 50/60Hz
Power consumption:		100VA
Communication ports:		Serial printer port connects thermal printer USB port connects PC
		SD card port saves data and measurement methods
		Accessories port connects and controls serval options
Weight:		4 kgs

**Accessories**

Code	Description
BOE 8620005	Test tube holder (only for S-200)
BOE 8622004	Rectangular long-path cuvette holder for cuvettes with 10, 20, 30, 50 and 100 mm path-length
BOE 8620003	Micro-cuvette holder, for cuvettes with centre height of 15 mm
BOE 8620020	Flow cuvette holder, incl. quartz glass flow cuvette of 150 µl
BOE 8620030	Set of Auto sample sipper and Flow cuvette holder with quartz glass flow cuvette of 150 µl
BOE 8622040	Electronic thermostat (Peltier element) TC cuvette holder (only for S-220, S-300)
BOE 8620050	Automatic 5 position cuvette holder
BOE 8620060	Thermo printer with 100V-240V AC power supply
BOE 8620001	Tungsten halogen lamp (S-200)
BOE 8622001	Xenon Lamp module (S-220, S-300)
BOE 8622070	UV DETECTIVE software to control and operate the spectrophotometer on a PC. The versatile software can control all spectrophotometer operations such as photometry, wavelength scans, time scans and more. Further functions include storage of methods programs, saving of numerical and graphical data, downstream data processing, data transfer to commercial spreadsheets such as Excel® and report generation

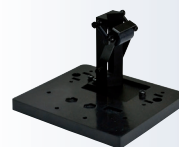

**TEST TUBE HOLDER**

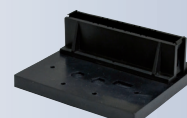

**LONG PATH CUVETTE HOLDER**

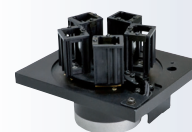

**5-PLACE AUTO SAMPLE HOLDER**

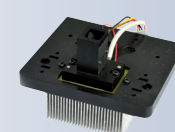

**ELECTRONIC THERMOSTAT HOLDER**

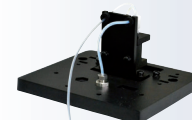

**FLOW CUVETTE HOLDER**



**SAMPLE SIPPER**



**THERMO PRINTER**

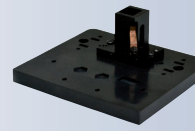

**MICRO CUVETTE HOLDER**

## BOECO LIFE SCIENCE SPECTROPHOTOMETER MODEL S-300

The BOECO S-300 life science spectrophotometer allows measurement of nucleic acid concentrations and purity (using ratio function) including protein concentrations. As a high quality spectrophotometer, the S-300 features touch screen operation packaged as a lightweight system with a compact footprint for life science and education related applications.



S-300

### ► Life Science Programs

The S-300 contains onboard functions for the quantification of nucleic acid, including dsDNA, ssDNA, RNA and Oligonucleotides. The purity of the nucleic acid can also be determined with the ratio A260/A280 calculation. Protein concentrations can be measured from a range of colourimetric assays such as Bradford, Lowry, Biuret and BCA. Standard calibration data and curves can also be displayed. Furthermore, proteins can be quantified at 280nm. Bacterial cell density at 600nm can also be measured under the OD600 cell culture optical density function. It can define a bacterial culture in exponential growth phase and at the most appropriate time for harvest or induction.

### ► Compact Optics with Full Range Scanning

The single beam optics are compact resulting in significant bench space saving. The long life Hamamatsu Xenon lamp optics system in the S-300 ensures quick and reliable performance.

### ► Color Touch Screen Operation

The intuitive color touch screen provides simple access to an extensive range of function. The touch screen is sensitive to stylus or hands (with and without gloves). Icon driven on board software improves accessibility and the quick action keys are another convenience feature.

### ► Various measurement modes

In addition to the Lifescience program, the S-300 also features conventional spectrophotometer functions such as single/ multiple wavelength analysis, spectrum scanning, kinetics and concentration measurement.

### ► Optional accessories

A various selection of optional accessories is available such as flow cell with sipper, temperature control holder, long path length cuvette holder & multiple cell holder to enhance different application needs.

### ► Storage and data output

External storage with SD card allows data export to PC in compatible text or spreadsheet format. Free downloadable PC Software MasterReport ([www.boeco.com](http://www.boeco.com)) allows data export to PC in compatible text or spreadsheet format for further data processing in the PC.

Method and result storage is almost unlimited by exchanging SD card when needed. Printer options are available for direct result printing with graphics.

### ► Validation function

To ensure optimum instrument performance, self diagnosis functions are equipped in GLP/GMP feature for performance validation and auditing.

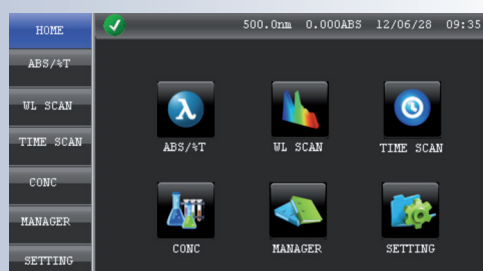

MAIN MENUE

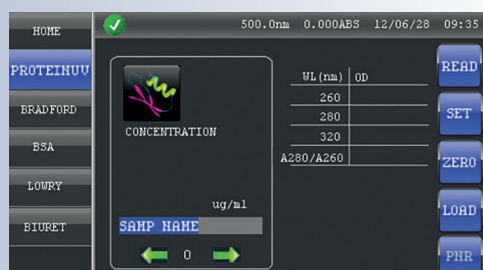
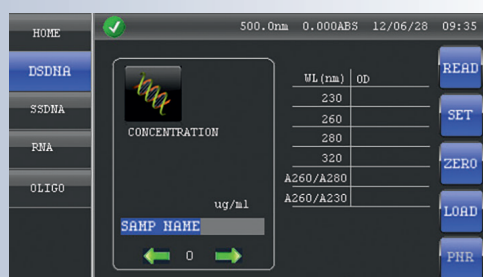

Code	Description
BOE 8630000	Model S-300 UV/Vis Life Science Spectrophotometer, single beam with full range scanning and color touch screen operation. Supplied with installed micro cuvette holder (centre height 15 mm) and with optional 10 x 10 mm cuvette holder and sample pack of 8 pcs. disposable UV Micro Cuvettes



<b>Specification</b>	<b>S-300 UV/Vis</b>
Wavelength Range:	190 to 1000nm
Wavelength Resolution:	0.2nm
Spectral Bandwidth:	5nm
Transmittance accuracy:	±1% T (NIST 930 Filter)
Transmittance repeatability:	0.50% T
Detection limit Concentration:	dsDNA 1.5 - 100µh/ml (for 100µl cell)
Noise level:	0.005 Abs (at 250 nm)
Stray light:	≤ 0.5% T at 220, 340 nm
Wavelength accuracy:	± 2nm
Wavelength repeatability:	≤ 1nm
Absorbance:	-0.3 to 1.999
Transmittance:	0 to 199.9%
Spectrum Scanning:	Yes
Concentration:	0 to 1999
Light source:	pulsed-Xenon lamp
Detector:	Silicon photodiode
Display screen:	4,3 inches colorful touch LCD screen
Printer:	specified 80-column thermal printer (series port)
Metering mode:	Single beam
Memory:	SD card storage
Time Scan:	Graphical and calculated reaction activity
Wavelegh Scan Analysis:	Absorbance and wavelength of peaks and valleys
GLP:	Real time clock and calendar, Self Diagnosis
Size:	400 (W) x 280 (D) x160 (H) mm
Power requirement:	AC, 100-240V, 50/60Hz
Power consumption:	100VA
Communication ports:	Serial printer port connects thermal printer USB port connects PC SD card port saves data and measurement methods Accessories port connects and controls serval options
Weight:	4 kgs

## TRAYCELL

The HELMA® TrayCell is a fibre-optic ultra-micro cell designed to the UV/Vis analysis of DNA/RNA and proteins. The dimensions of the TrayCell are equivalent to a standard cuvette in order to work in most spectrophotometers.

► **Efficient accessory**  
for your spectrophotometer

► **Extremely flexible and cost-effective solution**  
for the analysis of very small sample volumes (0,7 - 5µl)

► **Ideal for biomolecular laboratories**  
to perform the analysis of nucleic acids and proteins in very small volumes



<b>Specification</b>	<b>TrayCell 105.810-UVS</b>
Window material:	Quartz SUPRASIL
Wide/depth:	12,5 x 12,5 mm
Height:	59,5 mm
Volume:	0,7 - 5 µl
Light path:	0,2 mm or 1 mm (± 0,02) depending on the cap
Max. temperature:	50 °C
Centre height:	15 mm
Fibre optic cable:	built-in, not exchangeable UV/Vis low solarisation 190 nm - 1.100 nm



Code	Description
HEL 105810-A3-V1-46	TrayCell 105.810-UVS, centre height 15 mm
HEL 665-703-1-40	TrayCell Cap 665.703, 1 mm Light path
HEL 665-704-0.2-40	TrayCell Cap 665.704, 0,2 mm Light path

## CUVETTES

### Disposable Cuvettes:

Code	Description
BRA 759007	Disposable Macro Cuvettes, PS, Window: 10 x 35 mm; 10 mm light path Filling volume: min 2,5 / max 4,5 ml grouped by mold cavity number, neutral packing Wavelength: From 340 to 900 nm Packing: 100 pcs./box, 1000 pcs./carton
BRA 759017	Disposable Semi-Micro Cuvettes, PS, Window: 4,5 x 23 mm; 10 mm light path Filling volume: min 1,5 / max 3,0 ml grouped by mold cavity number, neutral packing Wavelength: From 340 to 900 nm Packing: 100 pcs./box, 1000 pcs./carton
BRA 759170	BRAND Disposable UV Macro Cuvettes, Filling volume: min 2,5 / max 4,5 ml grouped by mold cavity number, Wavelength: From 220 to 900 nm, 10 mm light path, pack of 100 pcs.
BRA 759150	BRAND Disposable UV Semi-Micro Cuvettes, Filling volume: min 1,5 / max 3,0 ml grouped by mold cavity number, Wavelength: From 220 to 900 nm, 10 mm light path, pack of 100 pcs.
BRA 759220	BRAND Disposable UV Micro Cuvettes, Center height 15 mm, Vol. 70 µl up to 550 µl, Wavelength: From 220 to 900 nm, 10 mm light path, pack of 100 pcs.

### Optical and quartz glass Cuvettes:

Code	Description
BOE 104010	BOECO economic Macro cell, Optical glass, 340-2500 nm 10 mm lighth path, PTFE lid, 2 pcs. / pack
BOE 204010	BOECO economic Macro cell, Quartz glass, 190-2500 nm 10 mm lighth path, PTFE lid, 2 pcs. / pack
HEL 6030-10-10	HELLMA Macro Cuvette 6030-OG without lid, Optical glass, 360-2500 nm. 10 mm light path
HEL 6030-UV-10-531	HELLMA Macro Cuvette 6030-UV without lid, Quartz glass, 260-2500 nm, 10 mm light path
HEL 6040-10-10	HELLMA Semi-Micro Cuvette 6040-OG without lid, Optical glass, 360-2500 nm, 10 mm light path
HEL 6040-UV-10-531	HELLMA Semi-Micro Cuvette 6040-UV without lid, Quartz glass, 260-2500 nm, 10 mm light path
HEL 100-10-20	HELLMA Macro Cuvette 100-OS with PTFE lid, Optical glass, 320-2500 nm, 10 mm light path
HEL 100-20-20	100-OS with 20 mm light path
HEL 100-50-20	100-OS with 50 mm light path
HEL 100-100-20	100-OS with 100 mm light path
HEL 100-10-40	HELLMA Macro Cuvette 100-QS with PTFE lid, Quartz glass, 200-2500 nm, 10 mm light path
HEL 100-20-40	100-QS with 20 mm light path
HEL 100-50-40	100-QS with 50 mm light path
HEL 100-100-40	100-QS with 100 mm light path
HEL 105-202-15-40	HELLMA Ultra-Micro Cuvette 105.202-QS with PE stopper, Quartz glass, 200-2500 nm 10 mm light path, Centre height 15 mm Chamber volume 50 µl, Filling volume 70 µl



MACRO



SEMI-MICRO



MICRO



BOE 104010



HEL 6030-OG



HEL 6030-UV



HEL 6040-OG



HEL 6040-UV



HEL 100-OS/10



HEL 100-OS/100



HEL 105.202-QS



## BOECO CLINICAL PHOTOMETER MODEL PM-51

- ▶ Semi-automated photometric system
- ▶ Effective temperature regulation system
- ▶ Flexible cuvette concept, interchangeable flow-through or standard cuvette
- ▶ Reagent-open system with high capacity for programmable methods
- ▶ Teach-in capability for reagent application via touchscreen
- ▶ Minimum sipping volume 250 µl
- ▶ Double-secured liquid control with infrared bubble detector
- ▶ Future-proof operation, can easily be upgraded



### Specification:

Type:	Semi-automatic, single-beam filter photometer
Light Source:	Halogen lamp - 12 V, 20 W with protection for lifetime
Wavelength:	340 nm - 800 nm
Wavelength Selection:	Automatic via 9-position filter wheel: 6 standard interference filters: 340 nm, 405 nm, 492 nm, 546 nm, 578 nm, 623 nm, 3 positions for optional filter of choice
Photometric Range:	0 - 2.5 Bel
Cuvette System:	Microflow cell: 32 µl, 10 mm light path interchangeable with normal standard cuvettes (macro or semi-micro, disposable or special optical glass) Temperature Control Internal Peltier element, temperature variable, pre-adjusted to 25 °C, 30 °C and 37 °C Equilibration time for aspirated reaction mixture to reach 37 °C from ambient temperature: 15 sec
Aspiration System:	Built-in peristaltic pump driven by stepper motor programmable aspiration volume controlled by infrared light barrier
Sipping Volume:	Minimum 250 µl, typically 500 µl up to 2000 µl Separate setting of aspirate volume and wash volume
Operator interface:	Touchscreen, for direct functions and alphanumeric inputs
Data Presentation:	Graphic display, White characters or symbols, blue background, lighted, resolution 240 x 126 dots.
Integrated Printer:	Thermal printer, 24 characters per line
Languages:	English, German, Spanish, French, Russian and Indonesian
Memory:	General operating software can be updated by PC Reagent open system with capacity for up to 231 programmable methods Import of data by touchscreen or PC
Data Logging:	Up to 50 non-linear calibration curves with max. 20 sets of points can be stored
Signal Port:	Up to 1000 results can be saved in memory automatically
Measurement Procedures:	1 serial port for connection to an external printer or PC (bidirectional interface)
	<ul style="list-style-type: none"> <li>▶ Absorbance</li> <li>▶ Endpoint with standard, factor or multiple standards, with or without reagent blank and/or sample blank</li> <li>▶ Bichromatic end point</li> <li>▶ Kinetics with standard, factor or multiple standards, with or without blank</li> <li>▶ Fixed time with standard, factor or multiple standards, with or without reagent blank</li> <li>▶ Turbidimetry with optional timer function</li> <li>▶ Single, double and triple determinations</li> <li>▶ Curve fitting for non-linear standard curves</li> <li>▶ Free hemoglobin in combination with optional interference filters</li> <li>▶ Kinetic: variable from 3 - 19 deltas, time per delta 4 - 255 sec.</li> <li>▶ Fixed time: variable from 0 - 65535 sec.</li> </ul>
Measuring Time:	Programmable from 0 - 65535 sec.
Delay Time:	Range 100 VAC up to 240 VAC at 50/60 Hz
Mains Supply:	Length 33 cm x Width 34 cm x Height 18 cm
Dimensions:	Weight: 5,3 kg
Weight:	

### Code

BOE PM-51

### Description

BOECO photometer PM-51, with integrated printer, flow-through cell, standard cuvette adapter and filter wheel (340-405-492-546-578-623 nm), 90-264 V, 50/60 Hz

## BOECO BMR-100 MICROPLATE READER

Our BMR-100 Microplate Reader is a reliable and robust instrument for a wide variety of research and clinical applications. It reads various kinds of 96-well plates and is equipped with shaking function. It can be used as a stand alone instrument or under PC control with a regular or APP software

- ▶ Easy to use with a 7 inch touch screen together with 3 external keys
- ▶ A broad wavelength range of 340-750nm
- ▶ Able to use as a stand alone or with PC control software to export the results
- ▶ Absorbance range: 0.0~4.000Abs
- ▶ 8 position optical filter wheel equipped with 4 standard optical filters
- ▶ Fast and accurate measurement of 96-well plates within 6 seconds

### Safety

The drawer is controlled by a motor, if there is anything blocked when it is closing, the motor would draw back to protect the user. The light source and optical filters can be exchanged without opening the cover.

### Software

BMR-100 keeps with high visual and logical user interface of software. It offers a comprehensive inbuilt calculation, such as blank subtraction, quantitative curve fit, qualitative classification and kinetic calculations, as well as the versatile reporting tool and further provides data reduction.

### Specification

Display:	7 inch touch screen (800x480 dots)
Light source:	Quartz-halogen lamp 6V/10W
Wavelength:	340-750 nm
Optical filter:	Standard filters 405, 450, 492, 630 nm
Half-bandwidth of filters:	3~9 nm
Read-out range:	0~4.000 Abs
Linearity (405 nm):	0~2.000 Abs $\leq \pm 1\%$ , 2~4.000 Abs $\leq \pm 2\%$
Resolution:	0.001 Abs 1
Accuracy (405 nm):	$\pm 1\%$ (0-3Abs), $\pm 2\%$ (3-4Abs)
Precision (405 nm) :	CV $\leq 0.2\%$ (0-3Abs), CV $\leq 1.0\%$ (3-4 Abs)
Test speed	<6s for 96 well plate
Incubator:	No
Shaking:	3 modes of shaking: slow, medium and fast
User interface:	Integrated software or PC control software
Operation:	Touch screen, 3 pcs external keys
Storage:	200 programs and 100,000 test records
Ports:	3 USB ports, for PC, printer and USB-disk
Dimensions (W x D x H)	440 x 295 x 225 mm
Weight:	10 kg

Code	Description
BOE 8160500	BMR-100 Microplate Reader with standard filters 405, 450, 492, 630 nm, 100-240 V, 50/60 Hz

### Optional Filters

BOE 8160511	Optical filter 340 nm
BOE 8160512	Optical filter 380 nm
BOE 8160513	Optical filter 415 nm
BOE 8160516	Optical filter 540 nm
BOE 8160518	Optical filter 570 nm
BOE 8160519	Optical filter 578 nm
BOE 8160521	Optical filter 595 nm
BOE 8160523	Optical filter 650 nm
BOE 8160514	Optical filter 690 nm



## BOECO IW-8 INTELISPEED MICROPLATE WASHER

The Intelspeed Washer IW-8 is designed for washing of standard flat-bottom 96 well plates and microstrips. The unit is fully programmable ensuring multi-step solution ripening, aspiration (aspiration, combination of aspiration/liquid dispensing and soaking, as well as soaking cycle during a particular period of time).

The unit has 100 user-defined programs. Standard version is supplied with 8-channel washing head for dispensing/aspiration, 3 bottles for washing and rinsing solutions, a waste bottle and bottle with filter. Optional 4-channel washing solution weight logger 4 CHW Logger is available.

The unit is designed for washing standard 96-well plates during analyses.

The unit provides:

- ▶ Washing mode
- ▶ Rinsing mode
- ▶ Mixing mode
- ▶ Double aspiration
- ▶ Possibility of additional solution mixing during time gap between two work cycles
- ▶ Possibility to use microtest plates by different manufacturers, ensured by automated plate set up (adjusting to different depths of plate wells)
- ▶ Plate and strip washing mode
- ▶ User-defined programs with adjustable parameters
- ▶ Saving work programs

The unit is designed for use in closed laboratory rooms at temperatures from +10 to +35°C and relative humidity up to 80% at +25°C decreasing linearly to 50% relative humidity at 35°C

4-channel washing solution weight logger 4 CHW Logger provides automatic control of rinsing solution and waste volumes. The washer shows remaining volume for each bottle as percentage and gives a warning message in case of low solution volume or full waste bottle when 4 CHW Logger is connected.

### Specification

Detection mode:	Absorbance
Minimum dispense volume:	25 µl
Maximum dispense volume:	1600 µl
Dispense increment:	25 µl
Dispensing accuracy:	±2.5%
Allowed residual liquid volume in plate well:	not more than 2 µl
Number of wells washed simultaneously:	8
Number of washing cycles for each channel:	1–15
Aspiration time:	0.2–3 s
Aspiration/dispensing speed:	3 levels
Max. number of channels in a program:	2
Soaking time:	0–300 s (increment 10 s)
Shaking time:	0–150 s (increment 5 s)
Number of washed rows:	1 – 12
Time of plate single wash (350 µl), no more:	45 s
Number of programs:	100
Plate platform and washing head movement:	automated
Indication of operation modes:	8-line LCD
Dimensions:	375 x 345 x 180 mm
Weight with accessories:	11 kg
External power supply:	DC 12 V, 5 A
Consumed power, not more:	60 W

### 4 CHW Logger Specifications

Max. loading per scale cup:	2 kg
Overall dimensions:	267 x 252 x 97 mm
Weight:	3 kg



Code	Description
BOE 8078000	IW-8 Intelspeed Microplate Washer, 100-240 V, 50/60 Hz incl. bottles & external power supply unit
BOE 8078010	4 CHW logger



# MILK ANALYZER

## BOECO MILK ANALYZER LAC-SP, LAC-SPA

The function of the BOECO Ultrasonic Milk Analyzer is to make quick analyses of milk samples directly after milking, at collecting and during processing.

The BOECO Milk analyzer makes quick analyses of milk and liquid dairy products as: Cow milk, UHT milk, Sheep milk, Goat milk, Buffalo milk, Camel milk, Whey, Cream (up to 45%), Skimmed milk (0,01% FAT, Ice-cream mixtures, Concentrated milk (up to 1160 kg/m<sup>3</sup>), Yogurt, Flavoured milk, Recovered milk.

Each unit will be delivered with 3 calibrations (standard are sheep, cow and UHT milk)

The model LAC-SP has one peristaltic pump for the sample aspiration. The model LAC-SPA has two pumps. The second one for automatic cleaning

The key features are:

- ▶ User-friendly: simple in operation, maintenance, calibration and installation
- ▶ Portable and compact design
- ▶ Very small quantity of milk required (25 ml per one measurement)
- ▶ Low power consumption
- ▶ No use of hazardous chemicals
- ▶ Measuring accuracy adjustment can be done by the user RS 232 interface
- ▶ ESC POS Printer Support
- ▶ Two samples self-calibration
- ▶ Dimensions 175x175x150 mm (WxDxH)
- ▶ Weight: < 1,5 kg
- ▶ Power: Input 100-240V ~1,6 A max, 50/60 Hz, Output +12V 4.17 A min

The following Parameters can be measured from the Ultrasonic system: Fat, Solid-non-fat (SNF), Density, Protein, Lactose, Milk sample temperature, Added water, Salts, Freezing point.

The following Parameters can be measured from integrated systems: pH (together with an electrode), Conductivity, Inhibitors

Parameter	Measuring range	Accuracy
Fat	from 0,01% to 25% (option 45%)	± 0.1%
SNF (Solids-non-fat)	from 3% to 15%	± 0.15%
Density	from 1015 to 1140 kg/m <sup>3</sup> (option 1160 kg/m <sup>3</sup> )	± 0.3 kg/m <sup>3</sup>
Protein	from 2% to 7%	± 0,15%
Lactose	from 0.01% to 6%	± 0.15
Added Water content	from 0% to 70%	± 3.0%
Temperature of milk	from 1°C to 40°C	± 1°C
Freezing point	from -0,4 to -0,7°C	± 0.001°C
Salts	from 0,4 to 1,5%	± 0.05%
pH	from 0 to 12	± 0,05%
Total solids	from 0 to 50 %	± 0,17%
Option		
Conductivity	from 3 to 14 (mS/cm)	± 0,05%

BOECO LAC-SP  
BOECO LAC-SPA



BACKPANEL

Code	Description
BOE 5290800	BOECO LAC-SP-50 Milk Analyzer, Standard Plastic Model, 50 sec. measuring time, with pH measuring system, USB/RS 232 dataport
BOE 5290860	BOECO LAC-SPA-50 Milk Analyzer, Standard Plastic Automat with 2 peristaltic pumps inside (1 for the sample, 1 for the cleaning) 50 sec. measuring time, with pH measuring system, USB/RS 232 dataport
BOE 5291860	BOECO LAC-SPA-50 Milk Analyzer, Standard Automat Model 50 sec. measuring time, with pH measuring system and integrated Conductivity measurement, real time clock, USB/RS 232 dataport
<b>Option:</b>	
BOE 5451160	High-fat (45%) / Density 1160 kg/m <sup>3</sup> measuring function

## BOECO MILK ANALYZER LAC-S, LAC-SA

The function of the BOECO Ultrasonic Milk Analyzer is to make quick analyses of milk samples directly after milking, at collecting and during processing.

The BOECO Milk analyzer makes quick analyses of milk and liquid dairy products as: Cow milk, UHT milk, Sheep milk, Goat milk, Buffalo milk, Camel milk, Whey, Cream (up to 45%), Skimmed milk (0,01% FAT, Ice-cream mixtures, Concentrated milk (up to 1160 kg/m<sup>3</sup>), Yogurt, Flavoured milk, Recovered milk.

Each unit will be delivered with 3 calibrations (standard are sheep, cow and UHT milk)

The standard model LAC-S has one peristaltic pump for the sample. The LAC-SA models have two pumps. The second one for automatic cleaning.

- ▶ Direct measurement of cold milk samples, starting at 5°C
- ▶ No need of periodical calibration
- ▶ The measurement accuracy is not dependant on milk's acidity
- ▶ High-end ultrasonic technology for analyzing any kind of milk
- ▶ Dimensions 100x223x216 mm (WxLxH)
- ▶ Weight: < 3 kg
- ▶ Power: Input 100-240V ~1,6 A max, 50/60 Hz, Output +12V 4.17 A min

The following Parameters can be measured from the Ultrasonic system:  
Fat, Solid-non-fat (SNF), Density, Protein, Lactose,  
Milk sample temperature, Added water, Salts, Freezing point

The following Parameters can be measured from integrated systems:  
pH (together with an electrode), Conductivity, Inhibitors

Parameter	Measuring range	Accuracy
Fat	from 0,01% to 25% (option 45 %)	± 0.1%
SNF (Solids-non-fat)	from 3% to 15%	± 0.15%
Density	from 1015 to 1140 kg/m <sup>3</sup> (option 1160 kg/m <sup>3</sup> )	± 0.3 kg/m <sup>3</sup>
Protein	from 2% to 7%	± 0,15%
Lactose	from 0.01% to 6%	± 0.15
Added Water content	from 0% to 70%	± 3.0%
Temperature of milk	from 1°C to 40°C	± 1°C
Freezing point	from -0,4 to -0,7°C	± 0.001°C
Salts	from 0,4 to 1,5%	± 0.05%
pH	from 0 to 12	± 0,05%
Total solids	from 0 to 50 %	± 0,17%
Option		
Conductivity	from 3 to 14 (mS/cm)	± 0,05%

Code	Description
BOE 5290090	BOECO LAC-S-50 Milk Analyzer, Standard Model, 50 sec. measuring time, with pH measuring system USB/RS 232 data port, USB flash drive
BOE 5290950	BOECO LAC-SA-50 Milk Analyzer, Standard <b>Automat (2 pumps)</b> , 50 sec. measuring time, with pH measuring system, USB/RS 232 data port, USB flash drive
BOE 5291950	BOECO LAC-SA-50 Milk Analyzer, Standard <b>Automat (2 pumps)</b> , 50 sec. measuring time, with pH measuring system and integrated Conductivity measurement, real time clock USB/RS 232 data port, USB flash drive

**Option:**  
BOE 5451160 High-fat (45%) / Density 1160 kg/m<sup>3</sup> measuring function

### Accessories

Code	Description
BOE 5290020	Thermal Printer
BOE 5095626	Basic pH combination electrode BA 17, liquid electrolyte, 0...14 pH, 0...100°C, with BNC plug, 1m cable. With leak proof refill opening, platinum diaphragm

USB  
FLASH  
DRIVE

BOECO  
LAC SA 50



Results  
F=03.02 S=07.93  
D=28.55 P=02.90  
L=04.35 W=04.23

Measurement  
results



BOECO LAC-SA  
with 2 peristaltic  
pumps inside,  
1 for cleaning, 1 for  
sample

USB dataport

input for alkaline detergent for automatic  
cleaning on every hour

The optional built-in conductivity  
sensor gives high performance  
freezing point analysis - avoid poor  
quality milk due to added water,  
detects mastitis and falsification with  
added salt



# SHAKER AND STIRRER



V1 PLUS

## BOECO VORTEX MIXER V1 PLUS

Vortex mixer V1 plus with variable speed control. Continuous operation as well as with automatic starter, triggered by pressing the attachment. Incl. standard attachment for test tubes up to 20 mm ø.

### Specification:

Kind of motion:	orbital, 4 mm
Speed range:	750 - 3000 rpm.
Time of acceleration:	3 sec.
Tube's capacity:	1,5-50ml
Speed display:	scale (min/max)
Switch:	touch / continuous mode
Overall size:	90 x 150 x 80 mm
Weight:	0,8 kg
Power:	12 V. DC 2,0A (External power adapter)

### Code

BOE 8055000

### Description

Vortex mixer V1plus, AC Adapter 100-240V with Multi plug (EU, US, UK, AU)



V2H

## BOECO VORTEX MIXER V2H

Heavy Vortex high speed mixer with brushless motor, digital display and optional attachments.

### Specification:

Motor:	brushless DC motor
Kind of motion:	orbital, 4 mm
Speed range:	300 - 4200 rpm. / speed accuracy: ± 10 rpm
Max. loading capacity:	500 g
Display:	digital speed / time setting
Switch:	ON / OFF / Touch
Pulse mode (default):	vibration for 5 secs. than pause for 5 secs.
Pulse mode (programm):	vibration time & pause time can be defined by user between 1 to 99 secs.
Timer	1 to 999 mins. & continuous mode
Overall size:	205 x 136 x 138,5 mm
Weight:	2,8 kg
Power:	external power adapter, 1.6A

### Code

BOE 8062000

### Description

Vortex mixer V2H, with standard Vortex cup AC adapter 100-240V, 50/60Hz

BOE 8062001

Microplate/Microtube (20x1,5/2,0ml) attachment

BOE 8062003

Erlenmeyer flask attachment

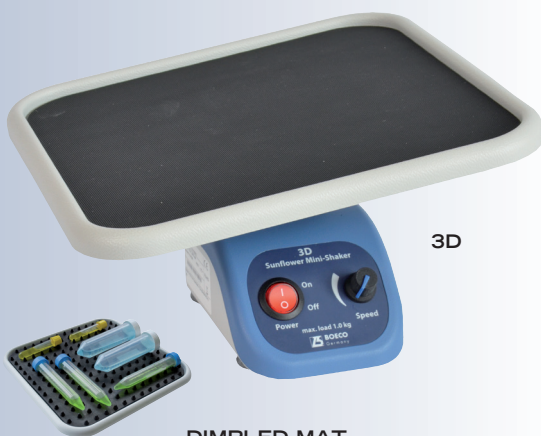

DIMPLED MAT

## BOECO SUNFLOWER MINI-SHAKER 3D

Mini-Shaker 3D with adjustable speed and constant angle of mixing. Very small and ideal for private diagnostics. Incl. black non-slip silicone mat.

### Specification:

Kind of motion:	three-dimensional orbital movement
Angle:	7°
Speed range:	50 - 60 rpm
Speed display:	scale (min/max)
Platform size:	215 x 215 mm
Overall size:	235 x 235 x 140 mm
Max Loading:	1 kg
Weight:	1,2 kg
Power:	12 V. DC 2,0A (External power adapter)

### Code

BOE 8058000

### Description

Sunflower Mini Shaker 3D, AC Adapter 100-240V with Multi plug (EU, US, UK, AU)

BOE 8050200

Dimpled mat



## BOECO COMBI-SPIN, FVL-2400N PLUS

this combination of a centrifuge and a vortex mixer for Micro test tubes is specially designed for the genetic engineering researches (especially for PCR-diagnostics experiments). It can be used also in biochemical clinical laboratories as well as microbiological and industrial biotechnology laboratories. Combi-Spin ensures the possibility for the simultaneous mixing and separation of the samples, using centrifuge and mixing modules

### Specification:

Rotation speed (constant): 2800 rpm (50 Hz), 3500 rpm (60 Hz)  
 Max RCF: 450 x g (50 Hz), 700 x g (60 Hz)  
 Continuous operation time: < 60 min  
 Accessories included: 1 rotor for 12 x 1,5 ml  
 1 rotor for 12 x 0,5 and 0,2 ml  
 Overall size: 190 x 235 x 125 mm  
 Weight: 1,7 kg



COMBISPIN  
FVL-2400N  
PLUS

Code	Description
BOE 8071000	Combi-Spin, FVL-2400N plus, 220V 50/60 Hz
BOE 8071100	Combi-Spin, FVL-2400N plus, 110V 60 Hz
BOE 8071001	SR-16, rotor for 2 x 8-well 0,2 ml microtest strips
BOE 8071002	SR-32, rotor for 4 x 8-well 0,2 ml microtest strips

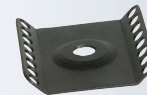

SR-16

## BOECO ROTATOR BIO RS-24

Mini-rotator with vertical rotation of the platform for soft mixing of test tubes, microtubes and vacutainers.

Incl. Standard platform PRS-22 for 22 tubes up to 15 mm diam.

### Specification:

Speed range: 5 - 30 1/min  
 Digital Timer: from 1 min to 23 h 59 min / non-stop  
 Overall size: 325 x 180 x 155 mm  
 Weight: 1,4 kg  
 Power: 12 V. DC 2,0A (External power adapter)



RS-24

Code	Description
BOE 8024000	Rotator Bio RS-24, with platform PRS-22, AC Adapter 100-240V with Multi plug (EU, US, UK, AU)
BOE 8073001	Platform PRS-4/12 (4x30 mm diam. and 12x15 mm)

## BOECO TUBE ROLLER TR-6

the microprocessor controlled BOECO TR-6 provides gentle rocking and rolling motion. The user can define programs (speed & time) and its Pulse mode provides a momentary pause for through mixing (Pulse can be set for a range of 30 sec. to 90 sec. time) The rollers are fully autoclavable and easy to remove which could allow to use bigger tubes.

### Specification:

Housing: Powder coated sheet metal (from 2019 ABS)  
 (from approx. 2019 plastic)  
 Motion: Rolling & Rocking  
 Teilt angle: ± 3°  
 Motor: Brushless DC motor  
 Speed range: 10 - 80 rpm / 1 rpm  
 Speed display: LED  
 Timer: 1 minute to 99 min. / non-stop  
 Roller: 6 Rolls / 5 positions (Nylon - autoclavable)  
 Roller Length: 327 mm  
 Max Loading capacity: 2 kg  
 Protection class: IP 21  
 Permissible ambient temp.: 4°C to 50°C  
 Permissible rel. humidity: <80°C  
 Input voltage: 100-240 VAC, 50/60 Hz  
 Output voltagw: 24VDC  
 Overall size: 500x301x93 mm (from 2019: 505x323x90)  
 Weight: approx. 6 kg (from 2019: 4,2 kgs)

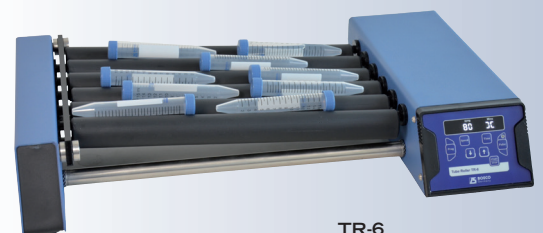

TR-6



TR-6 WITH PLASTIC BODY  
AVAILABLE IN APPROX 2019

Code	Description
BOE 8025000	Tube roller TR-6, AC adapter 100-240V, 50/60Hz



MMS 3000

## BOECO MAGNETIC STIRRER MMS 3000

Motor drive magnetic stirrer, with stainless steel plate and speed regulation up to 3000 rpm. An optional to be ordered detachable support rod allows to fix different sensors (temperature, pH etc.) inside the Liquid.

### Specification:

Speed range:	0 - 3000 1/min
Max. stirring volume:	up to 20,0 l
Platform size:	160 mm diam.
Platform material:	stainless steel
Support rod height:	320 mm
Overall size:	185 x 230 x 75 mm
Weight:	1,5 kg
Power:	12 V. DC 2,0A (External power adapter)

### Code

BOE 8056500

BOE 8056501

### Description

Magnetic stirrer MMS-3000, AC Adapter  
100-240V with Multi plug (EU, US, UK, AU)

Detachable support rod

Available Q3/2018 !

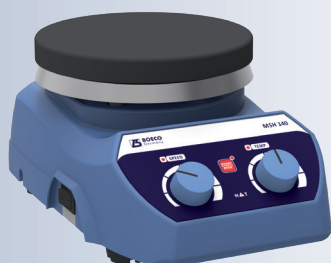

MSH 140



MSH 140 DIGITAL

## BOECO MAGNETIC STIRRER WITH HOTPLATE MSH 140, MSH 140 DIGITAL

Motor drive Magnetic stirrer with ceramic coated stainless steel hot plate for simultaneously stirring and heating of chemical reagents. „Hot-Surface“ alert indicator light when the plate temperature exceeds 50°C

### Specification:

	MSH140 digital	MSH140
Over all dimensions(LxBxH) (mm)	156x248x104	156x248x104
Set-up plate dimensions (mm)	140	140
Stirring quantity in Ltr (max)	10	10
Number of stirrer positions	1	1
Setup plate feature (Coating)	ceramic coated stainless steel plate	
IP Rating	IP 21	IP 21
Product weight (kg)	2,2	2,2
Safety temp circuit	Yes	no
Safe temp. (°C)	345	no
Power supply	110/240VAC	110/240VAC
Maximum bar size (mm)	25 - 60	25 -60
Speed range (rpm)	200 - 2200	200 - 2200
Heating temp. range (°C)	320	320
Hot surface alert (°C)	50	50

### Control

Time range	1 to 999 minutes & continuous	no
Motor type	DC	DC
Motor rating input & Output (W)	5-7	5-7
Accuracy in RPM (+/- RPM)	+/-80	-
speed step	10	-
Heat Output (W)	600	600
Power output (W)	610	610
Temp Accuracy [+/-K]	1	-
Temp increment	1	-
Temp indication	yes	no
Permissible ambient temp (°C)	5-40	5-40
Error code Display	yes	no
Housing Material	ABS	ABS
Display	Yes	no

### Code

BOE 8014000

BOE 8014001

BOE 8014110

BOE 8014111

### Description

Magnetic stirrer with hotplate MSH 140, 240V

Magnetic stirrer with hotplate MSH 140, 110V

Magnetic stirrer with hotplate MSH 140 digital, 240V

Magnetic stirrer with hotplate MSH 140 digital, 110V

### Accessories for MSH 140 digital

### Code

BOE 8014120

BOE 8014121

BOE 8014122

### Description

Support stand with boss head clamp for PT 1000 sensor probe

PT 1000 sensor

Reaction block, 500 ml

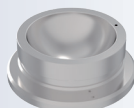
500 ML REACTION  
BLOCK

## BOECO MAGNETIC STIRRER WITH HOTPLATE MSH 420

Motor drive Magnetic stirrer with all in one glass-ceramic hot plate for simultaneously stirring and heating of chemical reagents.

The Glass-ceramic top plate is easy to clean, chemical-resistant, corrosion-resistant and scratch resistant.

The MSH 420 provides LED Indicators for Power, Heating and Stirring.

### Specification:

Speed range:	60 - 1110 1/min
Temperature regulation:	ambient temperature to 450 °C.
Max. stirring volume:	up to 15,0 l
Hot Platform size:	200 x 200 mm
Hot Platform material:	glass-ceramic
“Hot Top” indicator:	a “Hot” light illuminates if the temperature on the hot plate exceeds 55°C
Over-Heat protection:	The heating power will cut-off in abnormal situations by limiting top plate temperature to 550 °C and light flash
Overall size:	320 (w) x 210 (d) x 105 (h) mm
Heating power:	750 Watts
Weight:	3,6 kg



MSH 420

Code	Description
BOE 8054000	Magnetic stirrer with hotplate MSH 420, 220V
BOE 8054100	Magnetic stirrer with hotplate MSH 420, 110V

## BOECO OVERHEAD STIRRERS OST-25 / OST-40

- ▶ With digital display
- ▶ Compact size
- ▶ Brushless DC maintenance free long life motor
- ▶ The speed will remain constant even with changing viscosities
- ▶ Suitable for viscosities 10.000 and 30.000 mPas and volumes (25/40l)

Technical details	OST-25	OST-40
Stirring quantity (H <sub>2</sub> O):	25 l	40 l
Max. viscosity:	10.000 mPas	30.000 mPas
Motor rating input/output:	59 W / 45 W	
Output at stirring shaft:	42 W	
Max. ON-time	100%	
Max. torque at chuck (100rpm)	20 Ncm	40 Ncm
Speed range	50 - 2.000 rpm	50 - 1.000 rpm
Speed display:	digital (LED)	
Speed control:	stepless	
Setting accuracy speed:	± 1 rpm	
Reversible direction of rotation:	yes	
Power intermittent operation	yes, (resumes from last run)	
Chuck range:	0,7 - 10 mm	
Extension arm diameter:	13 mm	
Length of extension arm:	160 mm	
Timer (LED):	Yes	
Timer setting range:	1 min - 99 hr 59 min & continuous.	
Protection class:	IP 54 (acc. to DIN EN 60529)	
Protection:	Overload, overcurrent, overtemperature	
Voltage:	100-240 V	
Frequency	50/60 Hz	
DC voltage:	24 V	
Housing material	Thermoplastic polymer	
Dimensions in (WxHxD):	79 x 173 x 176 mm	
Net weight:	approx. 1,4 kg	

Code	Description
BOE 8901170	BOECO overhead stirrer OST-25, 100-240V, 50/60 Hz, <b>package</b> , incl. plate stand, boss head clamp, and 4-bladed propeller stirrer
BOE 8901180	BOECO overhead stirrer OST-40, 100-240V, 50/60 Hz, <b>package</b> , incl. plate stand, boss head clamp, and 4-bladed propeller stirrer



Available Q3/2018 !



PACKAGE WITH PLATE STAND, BOSS HEAD CLAMP AND 4-BLADED PROPELLER STIRRER INCLUDED





MR-1

## BOECO MINI-ROCKER SHAKER MR-1

provides gentle rocking motion. It is perfect for soft mixing of biological components. Incl. black non-slip silicone mat

### Specification:

Kind of motion:	rocking with fixed 7° angle
Speed range:	5 - 30 rpm
Speed display:	scale (min/max)
Timer:	digital, 1 min - 23h 59min / non-stop
Platform size:	215 x 215 mm
Overall size:	220 x 205 x 120 mm
Max Loading:	1 kg
Weight:	2,10 kg
Power:	12 V. DC 2,0A (External power adapter)

### Code

BOE 8058500

### Description

MR-1, Mini-rocker Shaker, AC Adapter 100-240V with Multi plug (EU, US, UK, AU)

## BOECO ROTATOR MULTI BIO RS-24

is an intelligent rotator for soft mixing microtubes and vacutainers. The BioRotator RS-Multi provides 3 types of motion, which can be used separately (except for vortex mode, which works in conjunction with reciprocal motion mode) and consecutively in a cycle:

### 1. Orbital motion



simple even circular motion - common type of motion used in Rotators. Adjustable speed from 1 to 100 rpm.

### 2. Reciprocal motion



vertical rotation with changing direction of rotation. Adjustable turning angle (from 1° to 90°, increment 1°) sets the limits for this type of motion. The speed is the same as set for rotational motion (from 1 to 100 rpm). In this type of motion there is a pause function (from 0 to 5 sec., increment 1 sec.) settable in the Vortex/pause mode.

### 3. Vortex motion



intensive mixing of samples at high speed with small amplitude - Vortex motion. The vortex mode is necessary for intensive mixing in and it is provided to decrease adhesion of solutions with tube surface, which is especially important for conducting microquantity research when the sample weight may be equal to the adhesion force. The vortex mode has an adjustable turning angle of 0° to 5° (increment 1°) and the timer has a pause function from 0 to 5 sec., increment 1 sec.)

### Specification:

Standard platform capacity:	PRS-26 for 26 (Microtubes and vacutainers)
Power:	12 V. DC 2,0A (External power adapter)
Size:	365 mm x 195 mm x 155 mm
Weight:	1,7 kg

### Code

BOE 8073000

### Description

Rotator Multi Bio RS-24, with platform PRS-26 AC Adapter 100-240V with Multi plug (EU, US, UK, AU)

BOE 8073002

Platform PRS-5/12 for tubes (5 x 30 mm diam. and 12 x 15 mm diam.)

BOE 8073003

Platform PRSC-10 for tubes 10 x 50 ml (Tube Diam 20-30 mm)

BOE 8073004

Platform PRSC-22 for tubes 22 x 15 ml (Tube Diam 10-16 mm)

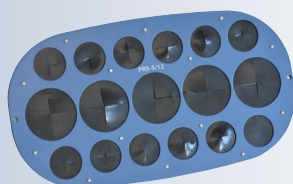
ROTATOR  
MULTI BIO RS-24

PRS-5/12



PRSC-10



PRSC-22

## BOECO MICROPLATE SHAKER PSU-2T

Specially designed for medical diagnostic. Orbital shaking platform IPP-2 with a holding mechanism for 2 standard microtiter plates.  
The use of direct drive and brushless motor allows continuous mixing up to 7 days and ensures reliable, trouble-free operation.  
The variable speed control provides an optimally adapted speed range from 150 to 1200 rpm with an orbit of 2 mm.

### Specification:

Orbit size:	2 mm
Speed range:	150 - 1200 1/min
Speed display:	scale (min/max)
Timer:	digital, 1 min - 23h 59min / non-stop
Overall size:	220 x 205 x 90 mm
Weight:	2 kg
Power:	12 V. DC 2,0A (External power adapter)

### Code

### Description

BOE 8052000	Microtiter Plate Shaker PSU-2T, incl. platform IPP-2 AC Adapter 100-240V with Multi plug (EU, US, UK, AU)
BOE 8052002	Platform IPP-4 for 4 Microtiter Plates



PSU-2T



PLATFORM IPP-4

## BOECO MICROPLATE INCUBATOR SHAKER PST-60 HL

The PST-60 HL shakers provide orbital shaking of the samples and have a heating platform for 2 x 96 or 4 x 96 wells microplates and an upper heating lid. The display indicates simultaneous set and actual time, temperature and shaking speed. The PST-60 HL are ideal for a variety of cytochemistry, immunochemistry, biochemistry and research applications.

### Specification:

Temperature regulation range:	25°C ..... 60°C	
Temperature setting resolution:	0,1°C	
Temp. Stability:	± 0,1 °C	
Temp. Uniformity over the platform:	± 0,25 °C	
Time of thermoblock heating from RT till 37°C:	12 min.	
Orbit :	2 mm	
Max. height of micotest plate:	18 mm	
Speed regulation:	250 -1200 rpm / increment 10 rpm	
Timer with sound signal:	1 min - 96 hrs, increment 1 min	
Power (external) :	DC 12 V. 5 A	
	PST-60 HL	PST-60 HL 4
Platform dimensions:	250 x 150 mm	210 x 290 mm
Number of microplates:	2	4
Size :	270x260x125 mm	380x390x140 mm
Weight incl. power supply :	6,1 kg	8,8 kg

### Code

### Description

BOE 8072000	Microplate Incubator Shaker PST-60 HL, for 2 plates, AC 100-240V, 50/60 Hz
BOE 8072040	Microplate Incubator Shaker PST-60 HL 4, for 4 plates, AC 100V-240V, 50/60 Hz



PST-60 HL PLUS



PST-60 HL 4 PLUS



OS-20 ILLUSTRATED WITH  
PP-4 PLATFORM

## BOECO UNIVERSAL ORBITAL SHAKER OS-20

Compact, low-profile, orbital laboratory shaker for versatile applications in the fields of biotechnology, microbiology and medical diagnostics. The OS-20 provides gentle rotational mixing and precise circulation at each point of the platform. Variable digital displayed speed control from 50-250 rpm. Digital timer for setting a time interval and continuous operation.

### Specification:

Kind of motion:	orbital
Orbit size:	20 mm
Speed regulation:	50 - 250 rpm
Speed display:	digital (LED)
Timer:	from 1 min to 999 min / continuous
Time display:	digital (LED)
Max. load:	2,5 kg excl. attachment
Power:	12 V. DC 2,0A (External power adapter)
Overall size :	265 x 270 x 70 mm (w/o attachment)
Weight:	3,2 kg.

### Code

BOE 8059000

### Description

Universal Orbital Shaker OS-20, AC Adapter 100-240V with Multi plug (EU, US, UK, AU)

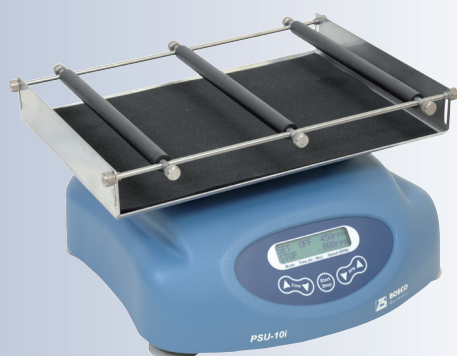

PSU-10i ILLUSTRATED WITH  
UP-12 PLATFORM

## BOECO UNIVERSAL ORBITAL SHAKER PSU-10i

Equipped with the direct drive system and brushless motor, our compact, powerful and quiet microprocessor controlled orbital laboratory shaker for many general purpose shaking applications. Speed and time setting are easy and during operation the LCD status display clearly indicates both set and actual speed, plus set and elapsed time.

### Specification:

Kind of motion:	orbital
Orbit size:	10 mm
Speed regulation:	50 - 450 rpm
Speed display:	digital (LCD)
Timer:	from 1 min to 96 hours / continuous
Time display:	digital (LCD)
Max. load:	3 kg excl. attachment
Power:	12 V. DC 2,0A (External power adapter)
Overall size:	220 x 205 x 90 mm (w/o attachment)
Weight:	3,4 kg

### Code

BOE 8069200

### Description

Universal Orbital Shaker PSU-10i, AC Adapter 100-240V with Multi plug (EU, US, UK, AU)

## ACCESSORIES FOR OS-20 AND PSU-10i

### PLATFORM PP-4

### Code

BOE 8059001

### Description

Dish platform PP-4 with silicone mat for Petri dishes, culture flasks etc. 235 x 235 mm

### PLATFORM UP-12

BOE 8059002

Universal platform UP-12 for all kind of flasks 285 x 215 mm, stainless steel with variable clamping rolls and silicone mat.

### PLATFORM P-6/250

BOE 8059003

Numbers of flasks at the platform  
100- 150 ml flasks max 12-9 pieces  
200- 250 ml flasks max 6-4 pieces  
500-1000 ml flasks max 4-2 pieces

### PLATFORM P-12/100

BOE 8059004

Platform P-6/250 with fixed clamps for 6 flasks 250/300 ml, 250 x 190 mm  
Platform P-12/100 with fixed clamps for 12 flasks 100/150 ml, 250 x 190 mm

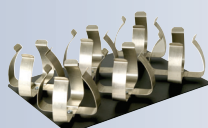



## BOECO PROGRAMMABLE ORBITAL SHAKER PSU-15i

The PSU-15i belongs to a generation of multifunctional mixing devices: The design, direct drive system, brushless motor (service life up to 35000 hours) and automatic loading balancing system make the PSU-15i even more reliable especially for the long non-stop operation. The PSU-15i has a microprocessor control which allows real-time program correction, indication of set and actual speed, angle and time, operation timer in the display.

### 1. Orbital motion



simple even circular motion - common type of motion used in shakers. Adjustable speed from 20 to 250 rpm.

### 2. Reciprocal motion



vertical rotation with changing direction of rotation. Adjustable turning angle (from 0° to 360°, increment 30°) sets the limits for this type of motion. The speed is the same as set for rotational motion (from 20 to 250 rpm).

### 3. Vortex motion of the platform (vibration)



intensive mixing of samples at high speed with small amplitude - Vortex motion. Adjustable turning angle of 0° to 5° (increment 1°)

### Specification:

Kind of motion:	orbital
Orbit size:	20 mm
Speed regulation:	20 - 250 rpm
Speed display:	digital (LCD)
Timer:	from 1 min to 96 hours / continuous
Time display:	digital (LCD)
Max. load:	8 kg
Continuous operation time:	max 168 hrs.
Power (external):	DC 12 V. 3,2 A
Overall size (w/o platform):	410 x 410 x 130 mm
weight:	11,7 kg

### Code

### Description

BOE 8079000	Orbital Shaker PSU-15i, 100-240VAC/12DC 4,16A without platform
-------------	--

### Accessories

### Code

### Description

BOE 8079010	Universal platform UP-330 for all kind of flasks 430 x 330 mm, stainless steel with 4 variable clamping rolls and rubber mat.
BOE 8080011	Flat platform PP-20, 480 x 380 mm
BOE 8080012	4 level platform PP-20-4, 480 x 380 x 170 mm Distance between platforms: 170 mm Total height: 510 mm
BOE 8080005	Universal tray platform, 360 x 360 mm with holes to accommodate clamps for Erlenmeyer flasks, separating funnels and test tube racks Clamps have to be ordered separately
BOE 8081001	Spring clamp, 25 ml max.: 36 pcs.
BOE 8081002	Spring clamp, 50 ml max.: 36 pcs.
BOE 8081003	Spring clamp, 100 ml max.: 25 pcs.
BOE 8081004	Spring clamp, 250 ml max.: 16 pcs.
BOE 8081005	Spring clamp, 500 ml max.: 9 pcs.
BOE 8081006	Spring clamp, 1000 ml max.: 9 pcs.
BOE 8081007	Spring clamp, 2000 ml max.: 4 pcs.
BOE 8081009	Holding device for Separating funnels 250-1000 ml



PSU-15i WITH PLATFORM UP-330



PSU-15i WITH TRAY PLATFORM



PP-20



PP-20-4

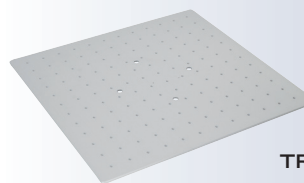

TRAY PLATFORM

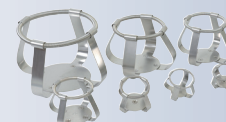

SPRING CLAMPS



HOLDING DEVICE FOR SEPARATING FUNNELS



Available Q3/2018 !



## BOECO ORBITAL SHAKER INCUBATOR ES-20/80

Our BOECO ES-20/80 shaker-incubator for biotechnological and pharmaceutical laboratories is a professional category equipment. The typical applications include microbiological and cell culture cultivation, protein expression, solubility studies, general mixing, as well as other various applications in the fields of biology and chemistry. The unit is equipped with a newly developed triple eccentric mechanism for platform motion that provides supreme balancing characteristics, superior reliability and quiet operation. The achieved stability of the unit during vigorous mixing allows for stacking installation of up to 3 units which enables to save space. The new display and easy to use user interface provide a clear and intuitive control of parameters and also allow data logging, storage and display over time. Additional features like out of balance sensor and automatic thermostat failure detection make this shaker-incubator an advanced and safe product. Bluetooth connectivity to PC allows for data management, data logging, parameter control and profiling in a dedicated software that can be requested separately.

A built-in heat-resistant brushless fan provides precise temperature distribution inside the chamber (from 10°C above ambient up to +80°C). Additionally, excellent sample temperature uniformity of  $\pm 0.3$  °C at 37 °C is achieved. The inner chamber is made of stainless steel. State-of-the-art motor, thermal insulation materials and parameter PID-control decrease the energy consumption and make the shaker-incubator highly energy efficient despite its relatively large size.

### Specification:

Speed control range	50–400 rpm (increment 10 rpm)
Digital time setting	1 min–96 hrs / non-stop (1 min increment)
Maximum continuous operation time	30 days
Maximum load	10,6 kg
Orbit	20 mm
Stacking	up to 3
Display	TFT
Data transfer	Bluetooth
Temperature setting range	+25°C... +80°C (increment 0,1°C)
Temperature control range	10°C above ambient... +80°C
Sample temperature uniformity	$\pm 0,3$ °C at 37°C
Temperature precision	$\pm 0,1$ °C at 37°C
Temperature accuracy	$\pm 0,1$ °C at 37°C
Sample temperature stability	$\pm 0,1$ °C at 37°C
Heat up time to max. temperature	75 min
Overall dimensions (WxDxH)	620 x 530 x 510 mm
Dimensions of the inner chamber	460 x 350 x 400 mm
Weight	48 kg
Nominal operating voltage	230 V, 50/60 Hz or 120 V, 50/60 Hz
Power consumption	230 V / 450 W (2 A) 120 V / 450 W (4.5 A)

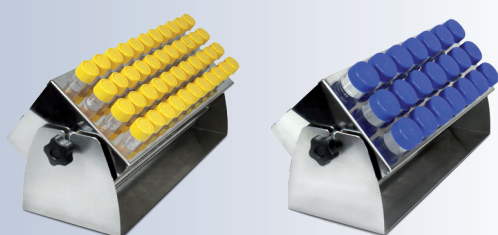
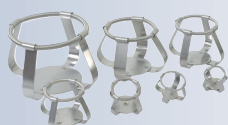

Code	Description
BOE 8086000	Orbital Shaker Incubator ES 20/80 230V, 50/60Hz, without platform
BOE 8086100	Orbital Shaker Incubator ES 20/80 120V, 50/60Hz, without platform

### Accessories

Code	Description
BOE 8086400	Platform PP-400 360 x 400 mm with silicone mat
BOE 8080005	Universal tray platform 360 x 360 mm clamps have to be ordered separately
BOE 8081003	Spring clamp, 100 ml max.: 25 pcs.
BOE 8081004	Spring clamp, 250 ml max.: 16 pcs.
BOE 8081005	Spring clamp, 500 ml max.: 9 pcs.
BOE 8081006	Spring clamp, 1000 ml max.: 9 pcs.
BOE 8081007	Spring clamp, 2000 ml max.: 4 pcs.
BOE 8086015	Test tube rack TR-44/15 for 44 x 15 ml tubes
BOE 8086050	Test tube rack TR-21/50 for 21 x 50 ml tubes

## BOECO PERSONAL DIGITAL INCUBATOR SI-22

due to its compact architecture the SI-22 provides an economical, efficient and space saving personal solution for incubating culture flasks, dishes, tubes and test plates.

A personal incubator avoids contamination and reagent confusion caused by multiple people using one machine.

The integrated UV light provides disinfection after use. The UV disinfection mode is blocked during incubation.

The SI-22 has a double-deck metal plate reinforced door with door open alarm and automatic turn off UV lamp function. The watch window adopts anti-UV-explosion-proof glass, which allows people to inspect running condition of the machine.

The inner chamber is made out of stainless steel and easy to clean.

A small cord port at the back of the unit allows the use of small mixers.

### Specification:

Volume:	22,5 l
Operating Temp. Range:	Room Temperature + 5°C... + 80°C
Temp. Uniformity:	± 0,65 (37°C)
Temp. Fluctuation:	± 0,65 (37°C)
Temperature Setting:	0,1°C
Ramping Time:	30 min.
Timekeeping Time:	99 hours, 59 min, 59 sec.
UV Disinfection Power:	6 W
Max. Number of shelves:	2
Internal Dimension:	273 x 300 x 304 mm (L x W x H)
External Dimension:	400 x 345 x 463 mm (L x W x H)
Weight net:	18 kg

Code	Description
BOE 8038000	Digital Incubator SI-22, 220V, 50/60 Hz incl. 1 stainless steel shelf
BOE 8038100	Digital Incubator SI-22, 115V, 60 Hz incl. 1 stainless steel shelf

### Accessories

Code	Description
BOE 8038001	Additional perforated stainless steel shelf

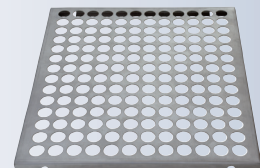

## BOECO ASPIRATOR WITH TRAP FLASK MODEL FTA-1

is designed for aspiration/removal of alcohol/buffer remaining quantities from microtest tube walls during DNA/RNA purification and other macromolecule reprecipitation techniques.

The FTA-1 can also be used for routine operations of cell washing from culture medium and resuspension in buffer.

A suction microbiological filter eliminates the risk of contamination from the trap flask with bacteria, viruses and infected particles.

### Specification:

Operating Principle:	Creating negative pressure in trapping flask using built-in microprocessor
Vacuum	-500mbar
Trap Flask vol.:	1000 ml
Dimension:	160 x 210 x 340 mm (with trap flask)
Power:	External power supply DC 12 V, 125 A
Net Weight:	1,7 kgs.

Code	Description
BOE 8039000	Aspirator with trap flask, model FTA-1
BOE 8039001	Optional 8-channel adapter manifold MA-8

MA-8 ADAPTER



SUCTION HYDROPHOBIC MICROBIOLOGIC FILTER



## BOECO COMPACT CO2 INCUBATOR S-BT

S-Bt Smart Biotherm is designed for work in the areas of cell biology (operations with animal cell cultures and tissues), molecular biology (DNA/RNA reaction analysis, hybridization reactions), biotechnology (synthesis of target proteins and other molecules), immunology (synthesis of antibodies and other proteins of immune system).

### Features:

- ▶ Six-sided heating: The heating elements are located on the walls and on the door, thus providing excellent uniform temperature distribution, regardless of external factors, such as ambient temperature and positioning of the device.
- ▶ Built-in infrared CO<sub>2</sub>-sensor allows an accurate control of the CO<sub>2</sub> level. The sensor makes measurement non-sensitive to changes in temperature and humidity inside the incubator.
- ▶ The chamber is made of stainless steel with smoothed seams to minimize contamination and to facilitate cleaning.
- ▶ The BOECO S-Bt is equipped with a UV air recirculation system - One UV lamp and a fan are mounted behind the rear wall, providing decontamination of the working volume.
- ▶ A convenient access port is built in the wall of the incubator for easy output of wire sensors or devices' installed inside. The access port is heated independently to prevent formation of condensate.
- ▶ An error tracing and alarm system lowers significantly potential risks during operation.
- ▶ The unit is equipped with a "black box" system that records temperature, humidity and CO<sub>2</sub> levels, as well as statuses for door opening, UV lamp, fan and errors, to the inner memory.
- ▶ Bluetooth connection to PC is available as an option.

### Technical details:

Working chamber material	Stainless Steel (1 mm)
Temperature setting range	+25°C ... +60°C
Temperature stability	±0.1°C
Temperature uniformity at +37°C	±0.3°C
Working volume	46 litres
Number of shelves	3 (max. 6)
Inner glass door	yes
Relative humidity	>90% @ 37°C
Humidity delivery	Water Pan
CO <sub>2</sub> control range	0 – 20%
CO <sub>2</sub> sensor	Infrared CO <sub>2</sub> sensor
Temperature and CO <sub>2</sub> level input	Digital
UV lamp	1 × 6 W, TUV G6T5
Data output	Wireless
Access port	1 (ø 26 mm)
Dimensions	400 × 410 × 580 mm
Weight	37.7 kg
Nominal operating voltage	230V, 50/60Hz; 115V, 50/60Hz

Code	Description
BOE 8087000	BOECO compact CO <sub>2</sub> incubator, 230V, 50/60HZ
BOE 8087100	BOECO compact CO <sub>2</sub> incubator, 115V, 50/60Hz

### Accessories

Code	Description
BOE 8087001	Additional shelf
BOE 8087002	PC Software and Bluetooth adapter
BOE 8087003	Incubator stacking device



# BOECO AUTOCLAVE BTE-23D

## Features:

- ▶ Three times fractionated pre-vacuum
- ▶ Stainless steel chamber
- ▶ LCD display
- ▶ Equipped with high quality and high performance pump
- ▶ 1 tray holder, 1 tray handle and 3 trays included
- ▶ High quality water pump and valves
- ▶ Independent steam generator
- ▶ Two samples self-calibration
- ▶ Overhead type water storage tank, easy to clean.
- ▶ Drying procedure: Dry by vacuum.
- ▶ Sterilization temperature: 121°C and 134°C
- ▶ Test programs: Helix test, B&D test and Vacuum test.
- ▶ Sterilization cycles: 9 cycles are available and 3 test programmes.

Program	Temperature	Pressure	Sterilization time	Total time
SOLID 134	134°C	2.1 bar	4 min	25-45 min
SOLID 121	121°C	1.1 bar	20 min	35-60 min
LIQUID 134	134°C	2.1 bar	10 min	35-60 min
LIQUID 121	121°C	1.1 bar	30 min	35-65 min
WRAPPED 134	134°C	2.1 bar	4 min	35-60 min
WRAPPED 121	121°C	1.1 bar	20 min	35-65 min
TEXTILE 134 (or wrapped)	134°C	2.1 bar	6 min	45-65 min
TEXTILE 121 (or wrapped)	121°C	1.1 bar	20 min	50-70 min
PRION	134°C	2.1 bar	18 min	45-70 min
B&D TEST	134°C	2.1 bar	3.5 min	22-35 min
Helix TEST	134°C	2.1 bar	3.5 min	22-35 min
Vacuum TEST	-	-	-	15-20 min

- ▶ It only have several buttons, very easy to use, any people can run it easily.
- ▶ All cycles are fully automatic; there is no need for human intervention in cycle management.
- ▶ Pressure protection locking system that ensures the door will not be opened once there is any pressure in chamber.
- ▶ Sterilization documentation: Integrated Micro Printer and USB port to store the information of the programme cycle in flash memory.
- ▶ The sterilization time and dry time can be adjusted by manual, ensure user to obtain best sterilization effects according to private requirements.
- ▶ Malfunction detection system, corresponding error code will be showed on the display once there is something going wrong.

## Safety:

- ▶ Warning system prevents starting a cycle if door is not properly locked.
- ▶ Triple threat protection for overheating and overpressure.
  - The pressure protection system will automatically cut off the electricity supply once the temperature of chamber inside is abnormally. Motorola pressure sensor is used to accurately sense the state of pressure inside chamber.
- Temperature control system is using high quality PT1000 temperature sensor, it is high precision, reliable service and prompt measurement, ensure accurate and timely transmission of temperature fluctuation.
- The safety valve will release steam in case the pressure inside chamber exceeds normal levels.

## Technical Information:

- ▶ Conform to CE and EN13060
- ▶ Manufactured under ISO 13485 norms
- ▶ Chamber Size: ø 247 x 450 mm (23 l)
- ▶ External dimension: 490 x 480 x 680 mm, Net weight 51 kg
- ▶ Packing box 750x560x460 mm, Gross weight 58 kg
- ▶ Power: 220V, 50/60 Hz or 110V, 60Hz

Code	Description
BOE 8902300	BOECO BTE-23D Bench Top Autoclave, Vol. 23 l. incl 1 tray holder, 1 tray handle and 3 trays, micro printer and USB port, 220V, 50/60Hz
BOE 8902310	BOECO BTE-23D as above but for 110 V, 60 Hz



BOECO BTE-23D

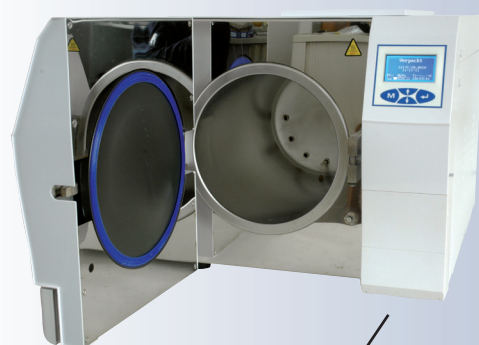

MICRO PRINTER AND USB PORT

This BTE-23D adopts 3 times pre-fractionated vacuum system, the following chart simply describes the status of its process

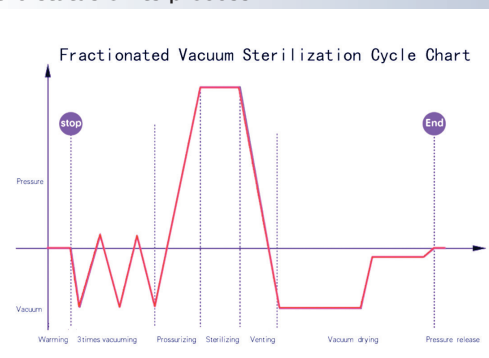



## BOECO FUEGO SCS BASIC SAFETY LABORATORY GAS BURNER

is a new standard among laboratory gas burners. With its innovative design this laboratory gas burner is suitable for all flame related applications in the laboratory.

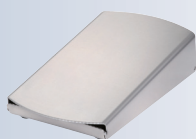

FOOT PEDAL

### Specification:

**Technology:** Microprocessor

### Programs

**Foot pedal:** Standard (flame during pressed foot pedal)  
Start-Stop with timer, 60 min

**Button:** Start-Stop with timer, 60 min

### Safety features

**Safety Control System (SCS) with gas safety cut off:** ignition and flame control  
temperature monitor  
burner head clogging and assembly monitor (BHC)  
automatic unit switch off, 4 h  
residual heat display

### Gas supply and consumption

**Gas connection:** 1/4" left with gas filter

**Gas types:** natural gas E/LL, 18 - 25 mbar  
liquid gas II2ELL3B/P, 20 - 50 mbar

**Connected load:** 70 g/h liquid gas

**Continuous cartridge operation:** CV 360 - 40 min, Express 444 - 50 min  
CG 1750 - 150 min, C 206 - 170 min  
CP 250 - 210 min, CV 470 - 370 min

### Temperatures

**Flame temperature:** 1350 °C on liquid gas  
1300 °C on natural gas (E)

### Electrical

**Power consumption:** 2VA

**Power connection:** 100 - 240 V / 50/60 Hz / max. 0,3 A  
9 V DC / 1A

### Mechanical

**Casing and operation controls:** stainless steel / glass,  
UV and solvent resistant

**Cover of burner shaft:** ø 23 mm, with drains

**Size (w x h x d):** 103 x 49 x 130 mm

**Weight:** 700 g

### Licenses

**DIN-DVGW Reg.-No:** NG-2211AS0167

**CE:** EN 61326-1, EN 61010-1

**EEC guidelines:** 2004 / 108 / EC, 73/23/EEC

### Code

### Description

BOE 8201000	BOECO Fuego SCS basic, Safety Laboratory gas burner with button function and foot pedal, 3 standard-programs for button (function knob) and foot pedal SCS (Safety Control System) with BHC (Burner Head Control), Removable and decomposable burner head Tild mechanism, right / left, Holding device for 3 inoculation loop holders. Nozzles for natural gas, propane / butane gas, Turbo flame Wrench 17 mm for gas connection, Screwdriver for burner head and cover of burner shaft. Tubing connector with swivel nut, Switching power supply
-------------	---

### Accessories

### Code

### Description

USB 5431	Inoculation Loop / needle holder, 230 mm,
USB 5460	Inoculation Loop, st. steel wire ø 0,6mm, ø loop 1,5mm
USB 5461	Inoculation Loop, st. steel wire ø 0,6mm, ø loop 2,5mm
USB 5462	Inoculation Loop, st. steel wire ø 0,6mm, ø loop 4,0mm



## BOECO WATER BATH PWB-4 AND PWB-8

The personal advanced PID microprocessor controlled waterbath PWB-4 and PWB-8 with their specification, easy operation and small foot print are designed for chemical, pharmaceutical, medical and biological routine laboratory use and as well as for research purpose.

### ► Control Panel:

Easy setting and operating, adjustable temperature, alarm signal display Single Line 4 digitals LED

### ► Overheat Protection:

The power will automatically be turned off when the internal temperature is over 110 °C

### Specification

	PWB-4	PWB-8
Capacity:	4 l	8 l
Temperature Range:	Room Temperature +5°C.. +99,9°C	
Temperature Setting:	0,1°C	
Uniformity:	± 0,2 (37°C)	
Fluctuation of Temp.:	± 0,5°C (RT + 5 - 80°C), ± 0,8 (80 - 99,9°C)	
Heating Time:	≤ 100 min (from 30°C to 95°C at RT 25°C)	
Input Power:	400 W	600 W
Water outlet:	No	Yes
Bath Inner Dimensions: (LxWxH mm)	238x135x146	325x265x150
Outside Dimensions: (LxWxH mm)	380x212x250	445x285x316
Weight (net):	6,5 kgs	8 kgs

### PWB-4

Code	Description
BOE 8036000	Waterbath PWB-4, without lid, 220V, 50/60 Hz
BOE 8036100	Waterbath PWB-4, without lid, 115V, 60 Hz

### Accessories for PWB-4

Code	Description
BOE 8036001	Gabled plastic lid
BOE 8036002	Flat stainless steel lid with 2 concentric rings
BOE 8036018	Test tube rack st. steel with 41 x 18 mm ø holes
BOE 8036015	Test tube rack st. steel with 41 x 15 mm ø holes
BOE 8036003	Flask tray, stainless steel

### PWB-8

Code	Description
BOE 8037000	Waterbath PWB-8, without lid, 220V, 50/60 Hz
BOE 8037100	Waterbath PWB-8, without lid, 115V, 60 Hz

### Accessories for PWB-8

Code	Description
BOE 8037001	Gabled stainless steel lid
BOE 8037002	Flat stainless steel lid with 4 concentric rings
BOE 8037018	Test tube rack st. steel with 76 x 18 mm ø holes
BOE 8037015	Test tube rack st. steel with 76 x 15 mm ø holes
BOE 8037003	Flask tray, stainless steel



FLAT LID FOR PWB-4



GABLED PLASTIC LID FOR PWB-4



TEST TUBE RACK FOR PWB-4



FLASK TRAY FOR PWB-4

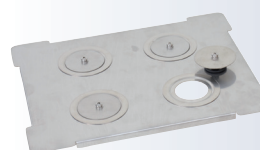

FLAT LID FOR PWB-8

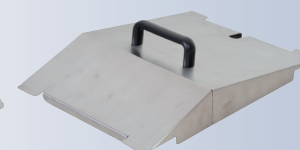

GABLED LID FOR PWB-8



TEST TUBE RACK FOR PWB-8

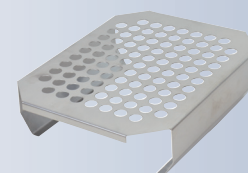

FLASK TRAY FOR PWB-8

## BOECO MUFFLE FURNACE MF 8/1100

our new muffle furnace, designed for materials testing, heat treatment, ceramic and stoneware samples firing. The furnace can be used in laboratories, educational institutions, ceramic studios and industrial laboratories.

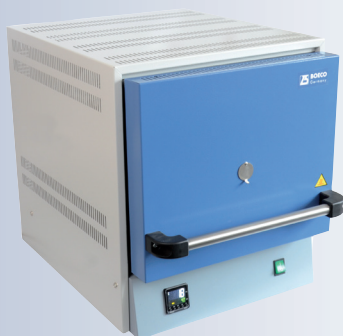

### Standard design of furnace

- ▶ Maximum temperature 1100°C
- ▶ Capacity 8.2 L
- ▶ High thermal efficiency
- ▶ Vacuumed ceramic fiber chamber
- ▶ Heating elements are embedded in fiber
- ▶ High quality thermoinsulation materials
- ▶ Door safety interlock switch
- ▶ Ceramic bottom plate
- ▶ Fast heating time
- ▶ Low power consumption
- ▶ Good stability and uniformity

### Control

- ▶ Microprocessor temperature controller (Omron E5CC)
- ▶ Temperature measurement by thermocouple type "K"
- ▶ PID electronic regulator, double digital display reference temperature and measured temperature



### Technical details:

	MF 8/1100
Useful volume	8,2 L
Rated power not more than	1.8 kW
Rated supply voltage	230 V
Rated frequency	50/60 Hz
Number of phases	1
Continuous operating Temperature	1100°C
Maximum temperature	1100°C
Working chamber material	Fibre muffle
Maximum heating- up time (without charge)	50 min
Temperature stability in working chamber at rated temperature in thermal steady state without charge not more than	±2°C
Temperature uniformity in working space at rated temperature in thermal steady state without charge not more than	±10°C
Furnace working chamber dimensions	
width	200 mm
depth	300 mm
height	133 mm
Furnace dimensions:	
width	440 mm
depth	620 mm
height	510 mm
Weight ( Netto)	28 kg

Code	Description
BOE 8641100	BOECO Muffle Furnace, MF 8/1100, 230V, 50/60Hz

## BOECO PCR WORKSTATION WITH UV AIR RECIRCULATOR, TYPE UVC/T-AR

For the preparation of PCR reactions and many other methods in molecular biology, a contamination-free working environment is required. The UVC/T-AR PCR Workstation is designed for DNA/RNA decontamination in the laboratory working place.

The UVC/T-AR is a bench top model, constructed from metallic skeleton and plexiglas and has a painted metal working place and a digital timer control of UV exposure. One open 25 W UV-lamp substantially decreases contamination level during UV-exposure (15-30 min).

White 15 W lamp provides local illumination of the working place and ensures good conditions for visual control of operation.

The model UVC/T-AR includes not only traditional UV source for direct lighting the surface of the inner working place of the PCR-box, but also additional UV air flow cleaner (UV - recirculator) for biosafety DNA decontamination to protect the user from direct UV-light during operation.

UV-recirculator consists of a UV lamp, fan and dust filters organized in a special box for maximum increasing (1000 x fold) density of UV-light leading sufficiently to effectivity of DNA inactivation. UV-recirculator generates 100 volumes of the PCR per 1 hour air flow exchange giving maximum aseptic conditions inside the box.

### Advantages

No HEPA filters, Ozone free high density UV decontamination  
Long living UV lamps (8000 hrs)-No noise, low energy consumption-  
Compact bench top for personal labs.

The PCR workstation UVC/T-AR is recommended for labs working in the fields of DNA analysis, genetic engineering, molecular biology.

### Specification

Direct UV-lamp light:	TUV 25W G13 UV-C Special Philips
Radiation type:	Ultraviolet (254 nm), ozone free
UV-lamp life time:	9000 hrs
UV-recirculator:	TUV 25W G13 UV-C Special Philips
Digital time setting of direct UV-exposure	1 min - 24 hrs
Luminiescent (visible light lamp)	15W/830 G13 Philips
Plexiglass type:	Polymethylmethacrylate
Optical transmission:	92 %
UV-protection:	99,9%
Thickness of plexiglass sides:	4 mm
Thickness of upper front side:	8 mm
Thickness of protective front screen:	8 mm
Working place:	650x475 mm
Overall size:	690x535x555 mm
Power:	100-240 V, 50/60 Hz, 67 W
Weight:	23,0 kg

Code	Description
BOE 8040000	PCR Workstation UVC/T-AR, 100-240VAC, 50/60 Hz



UVC/T-AR



## BOECO DRY BATH BLOCK INCUBATOR DBI-100, DBI-200

are ideal for incubation and activation of cultures, enzyme reactions, blood urea nitrogen determinations, immunoassays, melting/boiling points and a wide variety of laboratory procedures.

A supplied special block extraction tool allows to remove blocks easily.



### Specification:

Model:	DBI-100	DBI-200
Temperature control range:	RT +5°C - 105°C	
Display Accuracy :	± 0,1°C	
Temperature Stability @100°C	0,4°C	
Uniformity <sup>1)</sup> within the block @37°C	≤ 0,5°C	
Heating Time (20 to 105°C)	less than 15 min	
Timer:	1 min - 99 h 59 min	
Block Quantity:	1	2
Power, max:	120 W	240 W
Size mm :	250x190x130	365x210x150
Weight:	2,5 kg	4,5 kg

Code	Description
BOE 8018000	Dry Block Thermostat DBI-100, 200/240 V 50/60 Hz
BOE 8018100	Dry Block Thermostat DBI-100, 110/120 V 50/60 Hz
BOE 8019000	Dry Block Thermostat DBI-200, 200/240 V 50/60 Hz
BOE 8019100	Dry Block Thermostat DBI-200, 110/120 V 50/60 Hz

### Aluminium blocks with conical bottom for microtubes:

Code	Description
BOE 8018001	Block DB 01 for 96 x 0,2 ml PCR tubes
BOE 8018002	Block DB 02 for 45 x 0,5 ml tubes
BOE 8018003	Block DB 03 for 35 x 1,5 ml tubes
BOE 8018004	Block DB 04 for 35 x 2,0 ml tubes
BOE 8018005	Block DB 05 for 15 x 0,5 ml + 20 x 1,5 ml tubes
BOE 8018006	Block DB 06 for 20 x 1,5 ml + 15 x 2,0 ml tubes
BOE 8018007	Block DB 07 for 32 x 0,2 ml + 25 x 0,5 ml + 9 x 1,5 ml tubes

### Aluminium blocks with flat bottom:

Code	Description
BOE 8018008	Block DB 08 for 20 x 5 ml tubes Bore size: 14 mm Ø, Depth 40 mm
BOE 8018009	Block DB 09 for 20 x 10 ml tubes Bore size: 16 mm Ø, Depth 47 mm
BOE 8018010	Block DB 10 <sup>2)</sup> for 12 x 15 ml tubes Bore size: 16,9 mm Ø, Depth 58,5 mm
BOE 8018011	Block DB 11 <sup>2)</sup> for 6 x 50 ml tubes Bore size: 29 mm Ø, Depth 58,5 mm

### Aluminium blocks with round bottom:

Code	Description
BOE 8018015	Block DB 15 <sup>2)</sup> for 40 x 6 mm Ø tubes Bore size: 6,5 mm Ø, Depth: 33 mm
BOE 8018016	Block DB 16 <sup>2)</sup> for 28 x 10 mm Ø tubes Bore size: 10,5 mm Ø, Depth: 47 mm
BOE 8018017	Block DB 17 <sup>2)</sup> for 24 x 12 mm Ø tubes Bore size: 12,5 mm Ø, Depth: 47 mm
BOE 8018018	Block DB 18 <sup>2)</sup> for 24 x 13 mm Ø tubes Bore size: 13,5 mm Ø, Depth: 47 mm
BOE 8018020	Block DB 20 <sup>2)</sup> for 14 x 16 mm Ø tubes Bore size: 16,5 mm Ø, Depth: 47 mm
BOE 8018027	External Sensor, PT 1000

<sup>1)</sup> uniformity is measured with a sample height within the block

<sup>2)</sup> for blocks DB 10, 11 the lid cannot be closed, for blocks DB 15-19 the lid could only be closed if the tube height is less than 80 mm



DB-01



DB-02



DB-03



DB-4



DB-5



DB-06



DB-07



DB-08



DB-09



DB-10



DB-11



DB-15



DB-16



DB-17



DB-18



DB-20

## BOECO THERMO-SHAKER FOR MICROTUBES, TS-100

is a compact and cost-efficient solution for shaking and temperature control of small samples in 0,5 ml, 1,5 ml and 2,0 ml microtubes. The TS-100 is microprocessor controlled and has a display which indicates simultaneous set and actual time, temperature and shaking speed.

### Specification:

Orbit size:	2 mm
Temperature range:	25°C - 100°C
Speed range:	250 - 1400 1/min, increment 10 rpm
Acceleration time:	3 sec
Timer with sound signal:	digital, 1 min - 96 h increment 1 min
Power (external):	DC 12 V. 5 A
Overall size:	205 x 230 x 130 mm
Weight:	3,20 kg

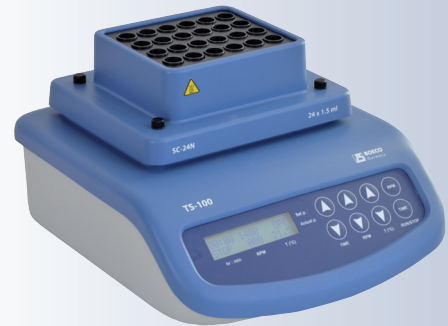

TS-100 with block SC-24N

Code	Description
BOE 8064000	Thermo-Shaker for microtubes TS-100, without block, AC 100-240V 50/60 Hz
BOE 8064001	Interchangeable block, SC-18 for 20x0,5 ml and 12 x 1,5 ml microtubes
BOE 8064004	Interchangeable block, SC-18/02 for 20x0,2 and 12 x 1,5 ml microtubes
BOE 8064005	Interchangeable block, SC-24N for 24x1,5 ml microtubes
BOE 8064007	Interchangeable block, SC-24 for 24x2,0 ml microtubes
BOE 8064006	Interchangeable block, SC-96A for 96-well PCR microplate

## BOECO THERMO-SHAKER FOR MICROTUBES, TS-100C

is a heating and cooling thermomixer. Active cooling using Peltier technology offers a temperature regulation range from +4°C to +100°C. Temperature control and mixing modes can be used simultaneously and independently. The TS-100C is microprocessor controlled and has a display which indicates simultaneous set and actual time, temperature and shaking speed. The low voltage power supply enables safe cold room or incubator operation. The TS-100C is applicable for DNA analysis, extraction of proteins, polysaccharids, lipids and other cell components

### Specification:

Speed range:	250 - 1400 1/min, increment 10 rpm
Acceleration time:	3 sec
Orbit size:	2 mm
Temperature control range:	15°C below room temp. to +100°C
Temperature setting range:	+4°C to 100°C
Average heating rate:	5°C / min (from +25 to +100°C in 15 min)
Average cooling speed:	From +100°C to +25°C: 5°C / min From +25°C to +4°C: 1,8°C / min
Timer with sound signal:	digital, 1 min - 96 h, increment 1 min
Power (external):	DC 12 V. 5 A
Overall size:	205 x 230 x 130 mm (w x d x h)
Weight:	3,7 kg



TS-100C with block

Code	Description
BOE 8064050	Thermo-Shaker for microtubes TS-100C, without block, AC 100-240V 50/60 Hz
BOE 8064051	Interchangeable block, SC-18C for 20x0,5 ml and 12 x 1,5 ml microtubes
BOE 8064054	Interchangeable block, SC-18/02C for 20x0,2 ml and 12 x 1,5 ml microtubes
BOE 8064057	Interchangeable block, SC-24NC for 24x1,5 ml microtubes
BOE 8064055	Interchangeable block, SC-24C for 24x2,0 ml microtubes
BOE 8064056	Interchangeable block, SC-96AC for 96-well PCR microplate

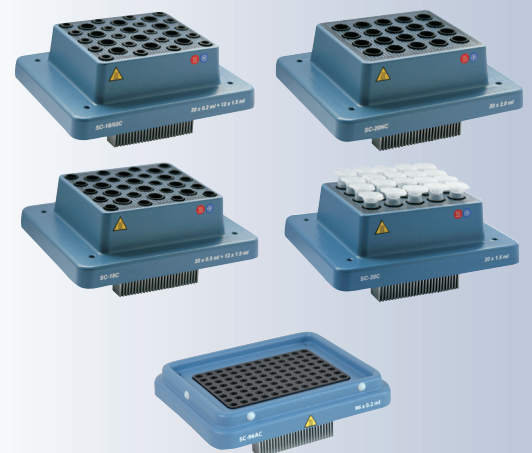



THERMAL CYCLER TC-SQ

## BOECO THERMAL CYCLER TC-SQ

is a personal Thermal Cycler with compact structure and small footprint and a friendly user interface with big LCD display which gives reliable results for teaching and research laboratories.

The TC-SQ provides superior performance especially in the cooling and heating speed, temperature control accuracy and uniformity of the block.

### Specification:

Sample Capacity:	24 x 0,2 ml, 8-strip, 24 x 0,2 ml plate
Temperature control range:	+ 4 ~ +99 °C
Heating rate (max.):	≥ 5,0°C /sec
Cooling rate (max.):	≥ 4,0°C /sec
Block temp. uniformity:	≤ ± 0,5°C
Block temp. accuracy:	≤ ± 0,3°C
Temp. of hot lid:	30°C - 110°C
Adjustability of hot lid press:	Yes
Temp. control mode:	Block or Tube
Display:	320 x 240 LCD
Program storage:	100 files
Max. segments	5 segments
Max. program steps:	16 steps
Max. cycles:	99 cycles
Size:	297 (L) x 212 (W) x 200 (H) mm
Weight:	3,2 kg
Interface:	RS 232

Code	Description
BOE 8085240	Thermal cycler TC-SQ, 220-240 V, 50/60 Hz with sample block for 24 x 0,2 ml
BOE 8085241	Thermal cycler TC-SQ, 100-120 V, 50/60 Hz with sample block for 24 x 0,2 ml

### Optional Block:

Code	Description
BOE 8085185	Sample Block for 18 x 0,5 ml

## BOECO THERMAL CYCLER TC-TE

is a personal Thermal Cycler with compact structure and small footprint and a friendly user interface with colored 5,7" touch screen and a fixed gradient block for 96 x 0,2 ml which gives reliable results for teaching and research laboratories.



THERMAL CYCLER TC-TE

### Specification:

Sample capacity:	96 x 0,2 ml, 8-strip, 24 x 0,2 ml plate
Cooling technology:	Peltier
Temperature control range:	+ 4 ~ +99°C
Heating speed of ramping:	up to 4,0°C /sec
Cooling speed of ramping :	up to 4,0°C /sec
Block temp. uniformity:	≤ ± 0,3°C
Block temp. accuracy:	≤ ± 0,1°C (55°C) ≤ ± 0,2°C (≥90°C)
Display resolution:	0,1°C
Temp. control mode:	Block or Tube
Ramping rate adjustable:	0,1°C - 4°C
Memories:	250 typical programs (unlimited by USB)
Max. cycles:	99 cycles for Nested PCR
Time up/down:	0-9 min59s, suit for LongPCR
Temperature up/down:	0,1 - 9,9°C suit for TouchdownPCR
Soak function:	Yes
Gradient range:	30°C ~ 99°C
Temp. differential range:	1°C ~ 30°C
Temp. of hot lid:	30°C -110 °C (Temp. / pressure adjusted)
Size:	335 (W) x 260 (D) x 270 (H) mm
Weight:	8 kg
Interface:	1 x USB
Power Supply:	100 - 240V, 50-60 Hz ≤ 600W

Code	Description
BOE 8089602	Thermal cycler TC-TE, 100-240 V, 50-60 Hz with gradient sample block for 96 x 0,2 ml



## BOECO THERMAL CYCLER TC-PRO

is a multifunctional compact sized thermal cycler equipped with high end Peltier technology. His five interchangeable sample block give the BOECO TC-PRO an exceptional versatility for PCR methods using tubes, strip wells or plates. Its high ramping rate and precision temperature control provide fast, accurate results. The extra large display and user-friendly interface make operation easy. The unit automatically recognizes which sample block is in place, eliminating the need for an operator to manually supply this information. The instrument can work either by itself or with computer control. One computer can control up to 30 sets of the thermal cyclers.

### Specification:

Temperature control range:	+ 4 ~ +99°C
Heating rate (max.):	≥ 4,0°C /sec
Cooling rate (max.):	≥ 4,0°C /sec
Block temp. uniformity:	≤ ± 0,3°C
Block temp. accuracy:	≤ 0,1°C (55°C), ≤ 0,2°C (90°C)
Temp. of hot lid:	30°C - 110°C
Gradient range:	1°C - 30°C
Temp. control mode:	Block or tube
Program storage:	≥ 100 files (No limitation with USB flash disk)
Max. segments	5 segments
Max. program steps:	16 steps
Max. cycles:	99 cycles
Power max.:	600 W
Size:	470 (L) x 340 (W) x 260 (H) mm
Weight:	6,3 kg (main body) + 4,2 kg (block)
Interface:	USB, LAN
Operation System:	Windows 7, Windows 2000 / XP / Memory:> 256M, Hard disk: >10G, CPU: Pentium 4)



THERMAL CYCLER TC-PRO

Code	Description
BOE 8085000	Thermal cycler TC-PRO, AC 110-240 V

### Interchangeable Blocks:

Code	Description
BOE 8085001	Block 96G: 96 x 0,2 ml gradient block

This aluminium alloy block and hot lid is for 96 x 0,2 ml microplate or tubes; 12 x 8 strip; 8 x 12 strip. This block can be used run gradient temperature programs. The temperature and hot lid are adjustable.

Code	Description
BOE 8085002	Block 384G: 384 wells plate gradient block

This aluminium alloy block and hot lid is for 384 well plates. This block can be used run gradient temperature programs. The temperature and hot lid are adjustable.

Code	Description
BOE 8085003	Block 3048: mixed block, 30 x 0,5 + 48 x 0,2 ml

This aluminium alloy mixed block and hot lid is for a max. of 30 x 0,5 ml 48 x 0,2 ml microtest tubes. The temperature and hot lid are adjustable.

Code	Description
BOE 8085004	Block 48D: dual block, 2 x 48 x 0,2 ml

This module consists of two separate aluminium alloy blocks, both for 0,2 ml microtest tubes, but each with its own hot lid. Each block accepts a maximum of 48 tubes for a total of 96 tubes. The temperature and pressure of the hot lids are independently adjustable.

Code	Description
BOE 8085005	Block 4I: block for 4 In Situ plates

This aluminium alloy block and hot lid is for 4 in situ plates. The temperature and hot lid are adjustable.



BLOCK 96G



BLOCK 384G



BLOCK 3048

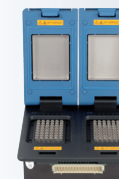

BLOCK 48D



BLOCK 4I



# HEATING MANTLES

- ▶ for operating temperatures up to 450°C
- ▶ for glass flasks, round bottom up to 20 l.
- ▶ flexible glass yarn heating element
- ▶ plastic coated metal housing
- ▶ thermally insulated and grounded
- ▶ predrilled threaded hole on rear allows connection of the clamp KM-SK (accessory)

## BOECO **LabHEAT**® KM-M SERIES

1,5 m power supply (earthed) cable with heating-zone switch



Volume ml/l	Flask ø mm	Power W	Heating zones	Order No. 220V AC	Order No. 110V AC
50	51	55	1	BOE 91000050	BOE 91500050
100	64	100	1	BOE 91000100	BOE 91500100
250	85	150	2	BOE 91000250	BOE 91500250
500	105	200	2	BOE 91000500	BOE 91500500
1	131	300	2	BOE 91001000	BOE 91501000
2	166	500	2	BOE 91002000	BOE 91502000
3	185	600	2	BOE 91003000	BOE 91503000
4	207	750	2	BOE 91004000	BOE 91504000
5	223	860	2	BOE 91005000	BOE 91505000
6	236	1000	2	BOE 91006000	BOE 91506000
10	279	1400	2	BOE 91010000	BOE 91510000
20	345	2000	2	BOE 91020000	BOE 91520000



## BOECO **LabHEAT**® KM-ME SERIES

designed identical to series KM-M, but in addition equipped with a built-in heating-zone switch and a power controller which allows a continuous adjustment of the heater power.

Volume ml/l	Flask ø mm	Power W	Heating zones	Order No. 220V AC	Order No. 110V AC
50	51	55	1	BOE 92000050	BOE 92500050
100	64	100	1	BOE 92000100	BOE 92500100
250	85	150	2	BOE 92000250	BOE 92500250
500	105	200	2	BOE 92000500	BOE 92500500
1	131	300	2	BOE 92001000	BOE 92501000
2	166	500	2	BOE 92002000	BOE 92502000
3	185	600	2	BOE 92003000	BOE 92503000
4	207	750	2	BOE 92004000	BOE 92504000
5	223	860	2	BOE 92005000	BOE 92505000
6	236	1000	2	BOE 92006000	BOE 92506000
10	279	1400	2	BOE 92010000	BOE 92510000
20	345	2000	2	BOE 92020000	BOE 92520000



## BOECO **LabHEAT**® KM-MER SERIES

designed identical to series KM-ME, but in addition equipped with a built-in separate switched magnetic stirrer with an infinitely variable speed range - up to 1600 rpm.

Volume ml/l	Flask ø mm	Power W	Heating zones	Order No. 220V AC
100	64	100	1	BOE 94000100
250	85	150	2	BOE 94000250
500	105	200	2	BOE 94000500
1	131	300	2	BOE 94001000



Code	Description
BOE 970000001	Support clamp KM-SK for the attachment of the metal-cased heating mantles to support rod or within support wall.

# VISCOMETER

## BOECO ROTARY VISCOMETER BRV 3000

is a rotational viscometer for fast determination of viscosity as specified in ISO 2555 and other ASTM norms. The BRV 3000 offers viscosity measurements which are 100 % compatible with Brookfield method and permits to carry out comparative measurements in accordance to recognized standards in quality control laboratories.

Viscometers are present in different industrial sectors - chemical, food, pharmaceutical, cosmetic and print industry - to measure viscosity beneath others of products like: adhesives, paints and coatings, inks, dairy products, hot wax, solvents, paper, pulp, gel, asphalt, chocolate, varnish, oils.

The BRV 3000 comes with under- and over range warning signal, RS 232 interface, temperature probe (PT 100) and has a digital display for direct reading of the following parameters:

Speed selected:	rpm
Spindle used:	Spindle Reference
Dynamic viscosity:	mPas or CP
Full scale percentage:	%
Sample temperature:	°C or °F
Auto range to display viscosity limits:	mPas or CP

Two different versions are available "L" for low to medium viscosity and "R" for medium to high viscosity.

They will be supplied with PC based Software "ViscosoftBasic", which allows to download data directly from the Viscometer. Measured values are shown in a chart and can be saved in Excel format for posterior evaluation.

### Scope of Delivery:

The BRV 3000 is supplied as a complete system in a very robust carrying case, incl. stand, a complete set of standard spindles with storage rack (4 spindles with version L and 6 spindles with version R), spindle guard, temperature sensor, ViscosoftBasic Software, calibration certificate and user manual.

Code	Description
BOE 8803001	BOECO BRV 3000 Rotary Viscometer L Version - for low to medium viscosity 3 - 2.000.000 mPas in 76 ranges 19 speeds with 4 spindles. 100-240V, 50-60Hz
BOE 8803003	BOECO BRV 3000 Rotary Viscometer R Version - for medium to high viscosity 20 - 13.000.000 mPas in 114 ranges 19 speeds with 6 spindles. 100-240V, 50-60Hz

### Optional accessories:

BOE 8803007	Special Spindel R1 applicable to version R. It allows to extend the lower viscosity limit: 5 - 33.000 mPas/cP
BOE 8803100	Adapter for low viscosity materials incl. coaxial spindle
BOE 8803110	Adapter for low viscosity materials with integrated temperature sensor
BOE 8803200	Adapter for small sample volumes
BOE 8803210	Adapter for small sample volumes with integrated temperature sensor
BOE 8803202	Special Spindel Set V1 L (TL5-TL7) for adapter for small sample volumes
BOE 8803203	Special Spindel Set V1 R (TR8-TR11) for adapter for small sample volumes
BOE 8803201	Adapter for helicoidal movement



# ROTARY EVAPORATOR

## BOECO ROTARY EVAPORATOR RVO 400 SD

- ▶ With digital display and control
- ▶ Water or oil bath
- ▶ Motorized lift
- ▶ Built in vacuum controller
- ▶ function of pressure and temperature gradient
- ▶ Variable inclination angle of evaporating flask
- ▶ With vertical or diagonal condenser
- ▶ fitted and designed for control and communication by PC



### Technical details:

Receiving flasks:	100 - 2000 ml
Evaporating flasks:	20 - 4000 ml
Rotation speed:	0 - 280 rpm
Bath temperature:	max. 100°C for water filling max. 180°C for oil filling
Regulation accuracy:	± 1°C up to 100°C ± 3°C up to 180°C
Pressure measurement:	absolute
Pressure difference:	adjustable 1-500 mbar.
Digital settings:	Temperature, rotations, vacuum
Gradient settings:	Temperature, pressure
Temperature unit selection:	°C, °K
Pressure units selections:	hPa, Torr
Cooler condensation size:	1200 sq cm (double spiral)
Switched vacuum pump:	output max 650 VA, input max. 2000 VA
Power supply:	230 V ±10%, 50/60 Hz
Power input:	max. 2000 W (excluding vacuum pump)
Dimensions in mm (WxHxD):	650 x 900 x 360 (incl. glass)
Net weight:	approx 20 kg

The RVO 400 SD conforms to the CE mark and all relevant EC standards and DIN norms and has been manufactured under ISO 9001:2000

Code	Description
BOE 8090020	BOECO Rotary Evaporator RVO 400 SD, with heating bath, motorized lift, built-in vacuum controller, digital measuring and control system with vertical condenser, 230 V
BOE 8090021	Idem for 110 V
BOE 8090030	BOECO Rotary Evaporator RVO 400 SD, with heating bath, motorized lift, built-in vacuum controller, digital measuring and control system with diagonal condenser, 230 V
BOE 8090031	Idem for 110 V

### Accessories:

BOE 8090005	Safety bath cover, Plexiglass
BOE 8090006	Wireless remote controller
BOE 8090007	PC-based evaporation control software

## BOECO CIRCULATION CHILLER COR 400

Performance:	1/4 HP
Performance 22°C =>7°C:	80 l/hour
Minimum temperature:	1°C for water
Minimum temperature:	-20°C for antifreezing mix
Regulation accuracy:	±1°C
Volume of cooling tank:	20 l
Displacement pump:	7 m
Pump flow:	120 l/hour
Cooling gas:	R - 134a
Power supply:	230V, 50/60Hz
Power:	max. 391 VA
Weight:	29 kg
Dimensions (w x d x h):	530 x 330 x 474 mm

Code	Description
BOE 8090010	BOECO Circulation Chiller, COR 400, 230V, 50/60Hz



SAFETY  
BATH COVER



## CHEMICAL RESISTANT VACUUM PUMP

- ▶ 100 % oil-free transfer
- ▶ Pure transfer, evacuation and compression
- ▶ TFM™ PTFE pump head combined with PTFE-coated diaphragm are ideal for extremely aggressive/corrosive gases and vapors.
- ▶ ATEX-compliant in accordance with ATEX II 2G IIB+H2 T3X internal atmosphere only
- ▶ Maintenance-free
- ▶ Gas tight, leakage rate approx.  $6 \times 10^{-3}$  mbar x l/s

### Specification:

Delivery:	20 l/min
Vacuum:	8 mbar abs.
Operating pressure:	1 bar
Connectors for tube:	ID 10 mm
Permissible media and ambient temp:	+5...+40°C
Weight / Dimensions WxHxD:	9,3 kgs / 154x207x312 mm



Code	Description
KNF 309577/026366	KNF LABOPORT® Diaphragm Vacuum Pump N 820.3FT.18, 220 V, 50 Hz, Pump head: TFM™ PTFE, Diaphragm: PTFE-coated, Valves: FFPM
KNF 309577/029163	Idem, 220 V, 60 Hz
KNF 309577/027170	Idem, 115 V, 60 Hz

The above pumps are suitable for our Rotary Evaporator RVO 400 SD

## BOECO VACUUM PUMPS R-300, R-400

are piston-powered, oil-free vacuum pumps, adaptable to many laboratory requirements.

- ▶ quiet and low vibration
- ▶ Compact and light weight
- ▶ Oil free and Maintenance-free

Specification:	R-300	R-400
Max. vacuum:	670 mm Hg	670 mm Hg
	50 Hz    60 Hz	50 Hz    60 Hz
Max flow rate:	17 l/min    20 l/min	34 l/min    37 l/min
Horse power:	1/8 HP	1/6 HP
Pole:	4 P	
Net weight:	4,1.kg	6,2 kg
Port thread:	5/16 inch (8 mm)	
Noise level:	50 db	



R-300



R-400

Code	Description
BOE 8830000	BOECO R-300 vacuum pump 220-240 V, 50/60 Hz
BOE 8830100	BOECO R-300 vacuum pump 110-120 V, 60 Hz
BOE 8840000	BOECO R-400 vacuum pump 220-240 V, 50/60 Hz
BOE 8840100	BOECO R-400 vacuum pump 110-120 V, 60 Hz

## BOECO VACUUM / PRESSURE PUMP R-430

### Specification: R-430

Max. vacuum:	630 mm Hg
Max. pressure:	80 psi
	50 Hz                      60 Hz
Max flow rate:	28 l/min                  34 l/min
Motor rotation:	1450 rpm                  1700 rpm
Horse power:	1/6 HP
Pole:	4 P
Net weight:	5,5 kg
Port thread:	5/16 inch (8 mm)
Noise level:	52,0 db



R-430

Code	Description
BOE 8843000	BOECO R-430 vacuum pump 220-240 V, 50/60 Hz
BOE 8843100	BOECO R-430 vacuum pump 110-120 V, 60 Hz





FILTRATION UNIT  
BOE 8833001

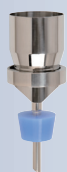

ST. STEEL  
FUNNEL  
BOE 16710310



MF 3



MF 3A



MV 3



MV 6



ADAPTER BOE 19010071  
to enable the use of the  
Magnetic filter holders MF3  
instead of the st. steel funnels  
at the above manifolds.

## Filtration Accessories

Code	Description
BOE 88330001	Filtration unit for 47-50 mm membrane filter with vacuum-resistant flask, capacity 1 litre
BOE 88300002	Glass filtration set for 47 mm membrane filter with 1 litre lab storage bottle
BOE 16710310	Stainless Steel funnel, 100 ml, 47 mm Diam.

## MAGNETIC FILTER HOLDERS

our MF series magnetic filter holders are designed with double-layer magnets to ensure a tight seal between the funnel and support base. The innovative design of a hose fitting detachable to the support base can allow a direct connection to the vacuum source and a flexible use with various kinds of vacuum flasks and bottles. Constructed of Polyether sulfone (PES) material, the MF series filter holders are resistant to a wide range of chemicals and high temperature. They are sturdy and autoclavable.

Specification:	MF 3	MF 3a
Funnel Capacity:		300 ml
Effective filtration area:		13,1 cm <sup>3</sup>
Effective Diameter:		41 cm
Filter size:		47 cm
Fitting Size (tubing):		Ø 4-8 mm
Graduation increment:		50 ml
Dimensions: (Ø x H)	9 x 17 cm	9 x 10,4 cm
Net Weight:	350 g	300 g
<b>Material</b>	Polyether sulfone (PES)	
	Funnel body, Funnel base, Hose fitting, Support screen	
Silicone rubber:	Sealing gasket, Sealing plug	
Lid kit:	PP (Polypropylene construction with PTFE syringe filter)	

Code	Description
BOE 20300010	Magnetic Filter Holder 300ml MF3 with lid, long stem and silicone stopper
BOE 20310010	Magnetic Filter Holder 300ml MF3a with lid, Short stem for direct application on general flask or lab bottles)

## STAINLESS STEEL MANIFOLDS

Applicable for microbiology test filtration in food, pharmaceutical, beverage industries. Medium purification in life science labs. General filtration for aqueous samples. Suspended solid test filtration for municipal surface ground and drinking water

Specification:	MV 3	MV 6
Number of branches:	3	6
Effective filtration area:	47 mm / 50 mm	
Port thread:	8 mm (5/16 inch)	
Dimensions: (h x w x d)	48x13x16cm	85x13x16cm
<b>Material</b>	Stainless steel (SS316)	
	Pipe - Control valve - Vent valve	
	Hose barb	
Aluminium:	Handles - Knob of control valve	
FKM:	Seals of control valve - Vent valve - Hose barb	

Code	Description
BOE 18030061	3-branch stainless steel (SS316) manifold MV 3 with 3 x stainless steel funnels 100 ml
BOE 18060061	6-branch stainless steel (SS316) manifold MV 6 with 6 x stainless steel funnels 100 ml
Optional	
BOE 16710311	Stainless steel cover for 100 ml stainless steel funnel
BOE 19010071	Adapter for silicone stoppers No.8, for use with MF3

## MINI DIAPHRAGM VACUUM PUMPS

are dry-running diaphragm Vacuum Pumps, adaptable to many laboratory requirements.

- ▶ 100 % oil-free transfer
- ▶ Pure transfer, evacuation and compression
- ▶ Maintenance-free
- ▶ Environmentally friendly
- ▶ High level of gas tightness

### Specification N 86.KN.18:

#### single head

Delivery:	6 l/min
Vacuum:	100 mbar abs. / 684 mm Hg
Pressure:	2,4 bar
Connectors for tube:	ID 4 mm
Permissible gas and ambient temp:	+5...+40°C
Motor protection:	IP 20
Weight:	1,9 kgs
Dimensions LxHxB:	164x141x90 mm



N 86.KN.18

Code	Description
KNF 046208/046242	KNF LABOPORT® Diaphragm Vacuum Pump N 86.KN.18, 220 V, 50 Hz, Pump head: PPS, Diaphragm: EPDM, Valves: FPM
KNF 046208/046948	Idem, 220 V, 60 Hz
KNF 046208/046241	Idem, 115 V, 60 Hz

#### Options:

KNF 001787	Fine control valve (suction side)
KNF 001786	Fine control valve (pressure side)

## BOECO COLONY COUNTER CC-1

is suitable for counting bacteria growing on agar contained Petri dishes. Built-in electronic register, operated by any pen. Every time a count is registered the beeper gives an audible signal to verify entry. The pressure sensor system provides uniform sensitivity over the whole of working field.

A reset button provides immediate zeroing of the 4-digit counter  
Flexible adjuster accepts 10 cm to 15 cm petri dishes  
The adjustable focusing arm allows the 1,5x magnifying glass to be placed at various angles of working position.  
The background plate can be changed to white or black for easy counting.  
Ring-shaped lamp provides uniform working field illumination.  
The number of counts is capable of being registered to maximum of 4-digits i.e. 9999 and displayed on bright red LED.

#### Specification:

Working Principle:	Pressure sensor system provides uniform sensitivity over the whole working field
Readout:	4-digit bright red, 0,6" LED display
Modes of Counting:	Marking pen counting (any pen)
Dimension:	30 x 33 x 10 cm (W x D x H)
Power:	115 / 230 VAC, 50/60 Hz
Net Weight:	5 kgs.

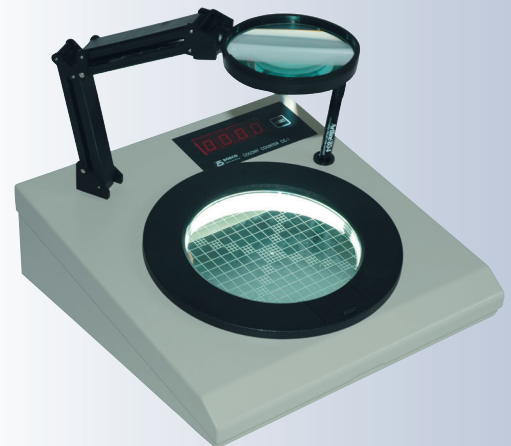

CC-1

Code	Description
BOE 5157000	Colony Counter CC-1, with 1,5x standard lens, adjustable focusing arm, marking pen, power cord

# WATER PURIFICATION

## LABORATORY WATER PURIFICATION SYSTEM BOECOpure PLUS

The all-rounder for H<sub>2</sub>O pure type ASTM I + ASTM II

If both, pure and ultra pure water in small quantities is required, BOECOpure PLUS is the perfect system.

The ability to provide both types from a single system results from the combination of ultramodern purification technologies. These also make it possible to connect the system directly to a drinking water tap.

A press on the dispenser button activates dispensing of ultrapure water type ASTM I via the digital dispenser control. The recirculation of the pure water held in the installed 10 litre tank keeps it permanently at type ASTM II quality. The pure water tank has a second outlet for feeding downstream end users.

### Features:

- ▶ OptiFill dispenser is standard
- ▶ TapWater set for direct connection to a drinking water tap
- ▶ 10-litre pure water tank has a pressure outlet
- ▶ Tank volume display in percent
- ▶ Simple and economical filter replacement
- ▶ Leakage sensor is standard
- ▶ Type ASTM I dispensing performance is 1,6 / 2 l/min.
- ▶ Type ASTM II draw-off is up to 6 l/h / 12 l/h
- ▶ Ready-to use, including filter cartridges  
(Pre-treatment cartridge with RO membrane and ultrapure water cartridge)

The BOECOpure PLUS UV is supplemented with UV-oxidation, 185/254 nm. The BOECOpure PLUS UV/UF is supplemented with an ultrafilter and UV-oxidation, 185/254 nm.

### ASTM Type I Ultrapure water applicable for

Molecular biology, microbiology, PCR, inorganic and organic trace analysis  
HPLC, ICP, TOC-analysis

### ASTM Type II pure water applicable for

Rinsing laboratory glassware, preparing and diluting buffers, reagents, tissue culture media and dyes.  
Sample preparation for analytical methods such as flame AAS



OPTIFILL DISPENSER

### BOECOpure PLUS UV/UF Flow chart

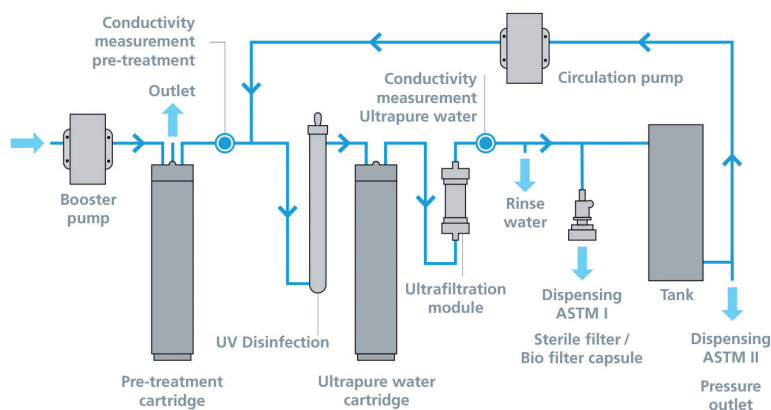

Specification BOECOpure PLUS:	Standard	UV	UV/UF
<b>ASTM II</b>			
Pure water performance at 15°C:	6 l/h	6 or 12 l/h	6 l/h
Conductivity:		0.067-0.1 µS/cm	
Resistance:		15-10 MΩ x cm	
Pure water tank pressurized outlet		yes	
<b>ASTM I</b>			
Conductivity:		0.055 µS/cm	
Resistance:		18.2 MΩ x cm	
TOC Value*:	5-10 ppb	1-5 ppb	1-5 ppb
Dispensing performance:	up to 2 l/min	up to 2 l/min	up to 1.6 l/min
Bacterial ** content:		< 1 CFU/ml	
Particles ** content:		< 1 ml	
Endotoxines*			0.001 EU/ml
<b>Feedwater requirements</b>			
Drinking water acc. to DIN 2000			
Feedwater temperature:		+ 2°C up to + 35°C	
Manganese and iron content:		< 0,05 mg/l	
Free chlorine content:		< 1 mg/l	
Silt density index (SDI):		max. 3	
<b>Technical data</b>			
Operating pressure in bar, min./max.		0,5-6 bar	
Supply voltage:		100-240 V / 50-60 Hz	
Connected load:		0.1 kW	
Connector size:		8 mm hose	
Ambient temperature:		+ 2°C up to + 35°C	
Dimensions ***, W x D x H:		390 x 725 x 615 mm	
Weight:		20/21 kg	

\*in dependence on the feedwater quality    \*\*with sterilizing filter 0,2 µm    \*\*\*with OptiFill Dispenser

Code	Description
BOE 8210051	BOECOpure PLUS Standard, 6 l/h Typical application: AAS, IC, ICP, buffers and media preparation
BOE 8210052	BOECOpure PLUS UV, 6 l/h
BOE 8210102	BOECOpure PLUS UV, 12 l/h Typical application: Ultra-trace analysis, ICP-MS, HPLC, TOC
BOE 8210053	BOECOpure PLUS UV/UF, 6 l/h Typical application: Life science and microbiology, cell culture media

#### Accessories / Consumables

Code	Description
BOE 8210005	Pre-treatment cartridge with RO-membrane, 6 l/h
BOE 8210010	Pre-treatment cartridge with RO-membrane, 12 l/h
BOE 8010003	Ultrapure water cartridge
BOE 19111300	Sterile filter capsule 0,2 µm
BOE 8510400	Sterile tank ventilation filter
BOE 8110200	Replacement UV-lamp
BOE 8010051	Replacement Ultrafilter
BOE 8210300	Wall-mount
BOE 16500030	Storage tank, 30 liter, with sterile overflow, sterile vent filter and pressure pump

#### Optional

The Pre-treatment pack for BOECOpure PLUS protects the reverse osmosis module against particulates, dirt, and colloids. For the complete pack the filter housing and prefilter have to be ordered.

Code	Description
BOE 16531110	Filter housing 10" without Pre-filter
BOE 16511100	Pre-filter insert 1 µm, 10"





# WATER STILLS

DEST 4



## DEST-4

standard water stiller with integrated low-water cut-off, continuous production of high pure water, free of dissolved metals and pyrogens

### Specification:

Distillate flow rate	approx. 4 l/h
Conductivity of distilled water (20°C)	1 µS/cm
Wattage:	3.000 W
Heater element:	Silica heater
Material of glass parts:	Borosilicate glass 3.3
Water consumption:	approx. 60 l/h
Size:	55 x 15 x 50 cm (lxwxh)
Weight:	approx. 4,5 kg

Code	Description
BOE 8704000	DEST-4, 230 V

DEST 4L



## BOECO DEST 4L

vertical water still with stainless steel boiler and borosilicate condenser. Integrated low-water cut-off, water inlet & flow regulator, continuous production of high purity distilled water, free of metal ions, salts, dissolved gases and pyrogenic substances. With flow regulator to avoid excessive water consumption.

### Specification:

Distillate flow rate:	approx 4 l/h
Conductivity of distilled water (20°C)	1,5 µS/cm
Heater:	3.000 W
Heater element:	Stainless steel (AISI 304)
Material of glass parts:	Borosilicate glass 3.3
Safety:	Low water cut-off & level switch
Water consumption:	approx. 55 l/h
Size:	690 x 280 x 280 mm (hxwxh)
Weight:	approx. 6,3 kg

Code	Description
BOE 8704200	DEST 4L, 230 V

DEST 10L



## BOECO DEST 10L

Vertical water still with 3 metallic heaters and a large surface condenser made of borosilicate glass 3.3. Designed for fully automatic operation, with an output of 10 liters per hour, includes safety features in case of lack of electricity supply or flow water supply. Automatic operation because of an included reservoir level control. If the distilled water is supplied to an external reservoir or flask the level control will unplug the water still DEST 10L if the reservoir is full and start again if the water level has been reduced in the reservoir.

### Specification:

Distillate flow rate:	approx 10 l/h
Conductivity of distilled water (20°C):	1,5 µS/cm
Heater:	3 x 2.200 W
Heater element:	Stainless steel (AISI 304)
Material of glass parts:	Borosilicate glass 3.3
Safety:	Low water cut-off & level switch
Water consumption:	approx. 1,5 l/min
Size:	36 x 40 x 96 cm (lxwxh)
Weight:	approx. 16 kg

Code	Description
BOE 8711811	DEST 10L, 230V, single phase
BOE 8711812	DEST 10L, 380V, 3-phase

## BOECO WS 4000 / WS 8000

Stainless steel water still with thermostatic low water cut-off and level switch which activates the heater if there is enough level of water in the boiler.

Specification:	WS 4000	WS 8000
Distillate flow rate:	approx 4 l/h	approx. 7,5-8 l/h
Cond. of dist water (20°C):	approx. 1,5 µS/cm	
Heater:	3 KW	6 KW
Cooling water:	approx. 60 l/h	approx. 84 l/h
Material: Inner part:	Stainless steel	
Outer part:	Stainless steel & powder coating	
Size: (h x w x d)	435x370x220mm	635x370x260mm
Switch:	Main power with pilot lamp	
Sealing:	Silicone gasket	
Safety:	Low water level & over heating cut-off	

Code	Description
BOE 8703600	WS 4000, 230 V
BOE 8703601	WS 4000, 110 V
BOE 8707500	WS 8000, 230 V



BOECO WS 4000 / WS 8000

## BOECO DEST TANK 4000 / 8000

Stainless steel water still for automatic and continuous operation with built-in 8/16 l storage tank. For bench and wall mounting. Supplied with wall mounting bracket. Excellent quality of distillation. An electronic level switch switches the still off when the storage tank is full and restarts it automatically when distilled water is withdrawn. Dispenser Tap of distilled water. With flow regulator to avoid excessive water consumption.

Specification:	TANK 4000	TANK 8000
Distillate flow rate:	approx. 4 l/h	approx. 8 l/h
Water tank capacity:	8 l	16 l
Cond. of dist water (20°C):	approx 1,5 µS/cm	
Power:	3.000 W	6.000 W
Cooling water:	approx. 55 l/h	approx 80 l/h
Material: Inner part:	Stainless steel	
Outer part:	Galvanized steel & powder coating	
Switch:	Main power with pilot lamp	
Safety:	Low water level & over heating cut-off	
Size (wxdxh):	620 x 330 x 460 mm	720 x 350 x 700
Weight:	approx. 24 kg	approx. 36 kg

Code	Description
BOE 8704500	DEST TANK 4000, 230 V
BOE 8704501	DEST TANK 4000, 115 V
BOE 8708000	DEST TANK 8000, 230 V



BOECO DEST TANK 4000 / 8000

## PRESSURELESS DEIONIZER DS 450

pressureless Ion exchanger in disposable cartridges of synthetic material. Excellently suited for medical practices and small laboratories requiring up to 10 litres a day. Supplied with conductivity meter, wall mount and a set of hoses.

Specification:	
Flow rate:	50 l/h
Capacity at 10° GSG:	425 l
Quality:	0,1 - 20 µS/cm
Temperature max:	30°C
Material:	Polyethylene
Size (h x diam.):	600 x 100 mm (incl. cond. meter)
Weight:	3 kg

Code	Description
BOE 11042506	Deionizer DS 450, 230 V, 50-60 Hz
BOE 11042507	Deionizer DS 450, 110 V, 60 Hz
BOE 11042706	Set of two replacement cartridges



## BOECO BIDEST 4

is our Bidistiller designed to work automatically with a production of 4 liters per hour, includes several safety systems to work continuously.

- ▶ Produces distilled water for the most common applications in the laboratory.
- ▶ Boiler and Condenser are made of borosilicate glass 3.3. The heaters are sheathed with quartz glass. This is ideal for producing high quality water, free of metal ions and pyrogens, with a conductivity 1-2  $\mu\text{S} / \text{cm}$ .
- ▶ Incorporates several security systems for automatic operation: presostat, electrovalve and level sensor.
- ▶ Cooling water outlet by rubber tube. The condensed water not flowing through the cooling water outlet.
- ▶ Energy saving through distillation of preheated cooling water.
- ▶ Distillation process visible through the front screen.
- ▶ The main switch and monitor drivers are on the front of the unit.
- ▶ Control of water level automatic cut off power in case of lack of water.
- ▶ Output of the distillate on the side of the unit.
- ▶ Output of carbon dioxide through hole of the top of condensers
- ▶ Suitable for wall mounting.

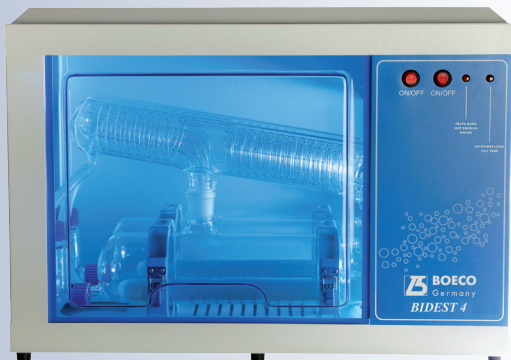

### Safety systems

#### Preostat

Safety thermostat protects still in the event of water supply failure.

#### Electrovalve

It cuts water and electrical supply to avoid useless expenses of water and electricity.

It returns to open water inlet if the electrical supply is enough to let the water still to work properly.

#### Level device

Device to fill a container without worrying when it finished. It cuts water and electrical supply to avoid useless expenses of water and electricity.

#### Specification:

Output:	approx. 4 l/h
Conductivity of distilled water (20°C):	1-2 $\mu\text{S}/\text{cm}$
pH:	Depends on tap water inlet 5,5-7
Heater:	2 x 3.000 W
Heater element:	Quartz sheathed heater
Material of glass parts:	Borosilicate glass 3.3
Water consumption:	approx. 1,2 l/min
Size:	70 x 36 x 47 cm (lxwxh)
Weight:	approx. 23 kg

Code	Description
BOE 8700410	BIDEST 4, 230V, 50/60 Hz, single phase

Note on the water output:

Depends directly on the quality of water supply and other environmental factors, maybe type III (according to ASTM). As distillates are open to the atmosphere before measurements can be made, the value of conductivity is really much less (down to 10 times) than it is really measured. Any ultra pure water in contact with the atmosphere has a conductivity of 1-2  $\mu\text{S}/\text{cm}$  and a pH of 5, due to the small amount of CO<sub>2</sub> (0.05 ppm) from the atmosphere.

# ELECTROCHEMISTRY

## BOECO PORTABLE PH/ORP/TEMP METER MODEL PT-380

- ▶ Simultaneous displays pH or mV and temperature.
- ▶ Convenient calibration with automatic buffer recognition of European and US buffer sets. Calibration data is stored in memory and is ready for use on power up.
- ▶ Automatic or manual temperature compensation
- ▶ Automatic lock mode and end point sensing are available to lock in stable readings.
- ▶ 50 data set reviewable memory.
- ▶ Automatic shut off function (30 minutes of non-use)
- ▶ Battery life 1000 hours
- ▶ Low battery indicator
- ▶ IP65 waterproof case

The PT-380 will be delivered incl. the following standard accessories:  
1 x ATC probe 6000AST, each 1 x 100 ml BOECO Buffer solution pH 4,01, pH 7,00, 1 x 9 V battery, 1 x operating manual, 1 x carrying case

### Specification:

**pH**  
**Range** -2 to 16,00 pH  
**Resolution** 0,01 pH  
**Accuracy** ± 0,01 ± 1 digit

**mV**  
**Range** -1999 to 1999 mV  
**Resolution** 1 mV  
**Accuracy** ± 0,1 %

**Temperature**  
**Range** -10,0 to 120,0 °C  
**Resolution** 0,1 °C  
**Accuracy** ±0,5 %

pH buffer recognition: US (4,01, 7,00, 10,01)  
NIST (4,00, 6,86, 9.18) user selectable

pH electrode offset Recognition: ±90mV at pH 7,00 or 6.86

pH electrode slope Recognition: ±30% at pH 4,00, 4,01, 9,18 or 10,01

pH temp. compensation: Auto / manual -10,0 to 120 °C

Input Impedance: 10<sup>12</sup> ohms

Temperature sensor: Thermistor, 10K ohms at 25°C

RS 232 interface: no

Power requirement: 9 Volt battery

Dimensions (LxWxH): 198x70x37 mm

Weight: 0,26 kg (1 x 9V Battery included)

Code	Description
BOE 5190380	Portable pH/ORP/Temperature meter, model PT-380 in carrying case with standard accessories without electrode



BOECO PORTABLE PH/  
ORP/TEMP METER  
MODEL PT-380



## BOECO ELECTRODES

The electrodes are not included with the pH meters and have to be ordered separately:

Code	Description
BOE 5190600	Basic pH combination electrode, BA ECO plastic PC shaft, gel electrolyte, 0...14 pH, 0...80°C, with BNC plug, 1m cable, glass sensor
BOE 5095695	Basic pH combination electrode BA 25, Noryl plastic shaft, gel electrolyte, 0...14 pH, -5...80°C, with BNC plug, 1m cable, fibre diaphragm
BOE 5095626	Basic pH combination electrode BA 17, glass shaft, liquid electrolyte, 0...14 pH, 0...100°C, with BNC plug, 1m cable. With leak proof refill opening, platinum diaphragm



BOECO ELECTRODES



## BOECO PH/MV/ION/TEMP BENCH TOP METER MODEL BT-675

- ▶ Large display with backlight
- ▶ Simultaneous display of pH / ORP and temperature readings
- ▶ Dual buffer set selection: (4,01, 7,00 10,01) or 4,00, 6,86, 9,18)
- ▶ Calibration data is stored in memory and is ready for use on power up.
- ▶ Resolution to 0,1 mV for Ion measurement
- ▶ Automatic or manual temperature compensation
- ▶ Automatic lock mode and end point sensing are available to lock in stable readings
- ▶ AC adaptor or battery power (low battery indicator)
- ▶ IP54 waterproof case

The BT-675 will be delivered incl. the following standard accessories:  
 1 x ATC probe, each 1 x 500 ml Buffer solution pH 4,01, pH 7,00  
 1 x AC adaptor, 1 x operating Manual, 1 x flexible electrode holder. 6 x 1,5 V  
 AAA batteries

### Specification:

#### pH

##### Range

0 to 14,00 pH

##### Resolution

0.01 pH

##### Accuracy

± 0,01

#### mV

##### Range

-1999,9 to 1999,9 mV

##### Resolution

0,1 mV

##### Accuracy

± 0,4 mV (-1500,0 -1500,0);  
 ± 1 mV (-1999,9 - -1500,0  
 and 1500,0 - 1999,9)

#### Temperature

##### Range

0,0 to 100,0°C

##### Resolution

0,1°C

##### Accuracy

±0,2°C

pH buffer recognition:

US (4,01, 7,00, 10,01) or  
 NIST (4,00, 6,86, 9,18) user selectable  
 0 - 60,0 °C

Buffer temp. range

pH calibration

1,2 or 3 point calibration

pH electrode offset

Recognition:

±1,50 pH

pH electrode slope

Recognition:

±30% at pH 4,00, 4,01, 9,18 or 10,01

pH temp. compensation:

Auto / manual 0,0 to 100°C

Input impedance:

10<sup>12</sup> ohms

Temperature sensor:

Thermistor, 10K ohms at 25°C

RS 232 interface:

no

Power requirement:

6 x 1,5 Volt AAA batteries or AC adaptor

Dimensions (LxWxH):

150 x 203 x 72 mm

Weight:

0,54 kg (batteries included)



BT-675

### Code

### Description

BOE 5196750	Bench Top pH/mV/Ion/Temp Meter, Model BT-675, AC adaptor with EURO plug with standard accessories, without electrode
BOE 5196751	Bench Top pH/mV/Ion/Temp Meter, Model BT-675, AC adaptor with US plug with standard accessories, without electrode

# BOECO MULTIPARAMETER PH/ORP/ CONDUCTIVITY/TDS/SALINITY/RESISTIVITY/ TEMP. BENCH TOP METER MODEL MBT-700

- ▶ LCD with backlight showing pH / ORP or Conductivity / TDS / Salinity and temperature readings
- ▶ Two channel measurement allows measuring pH/ORP and Conductivity/TDS/ Salinity simultaneously
- ▶ Up to 5 point calibration for pH and one point calibration for conductivity
- ▶ Automatic or manual temperature compensation
- ▶ Automatic buffer recognition (NIST and USA)
- ▶ Bluetooth function to connect to smartphone, tablets or PC
- ▶ When the unit is connected to a bluetooth device, the user can store data into the device that meets GLP requirements.

The MBT-700 will be delivered incl. the following standard accessories:  
1 x ATC probe, each 1 x 500 ml Buffer solution pH 4,01, pH 7,00  
1 x AC adaptor, 1 x operating manual, 1 x flexible electrode holder

## Specification:

### Conductivity K = 0,475

Range	Resolution	Accuracy
0,0 to 475µS/cm	0,1µS/cm	±1% of reading +2µS/cm
475 to 4750µS/cm	1µS/cm	±1% of reading +5µS/cm
4,75 to 47,50mS/cm	0,01mS/cm	±1% of reading +0,05mS/cm
47,5 to 200,0mS/cm	0,1mS/cm	±2,5% of reading +0,5mS/cm

### Conductivity K = 0,1

Range	Resolution	Accuracy
0.00 to 99,99µS/cm	0,01µS/cm	±1% of reading
100 to 200µS/cm	0,1µS/cm	±1% of reading

### TDS

Range	Resolution	Accuracy
0,001mg/l to 200,0g/l	0,001/0,01/0,1/1mg/l	±0,5% Full Scale 0.01/0,1 g/l

### Salinity

Range	Resolution	Accuracy
0.0 to 80,0 ppt	0,1 ppt	±0,5 % Full Scale

### pH

Range	Resolution	Accuracy
-2,00 to 16,00 pH	0,01 pH	±0,01pH

### mV

Range	Resolution	Accuracy
-1999,9 to 1999,9 mV	0,01 mV	±0,05% Full Scale

### Temperature

Range	Resolution	Accuracy
-10,0 to 120,0°C	0,1°C	±0,4°C

pH buffer recognition:	US (1,68 4,01, 7,00, 10,01, 12,46 or NIST (1,68, 4,00, 6,86, 9,18, 12,46)
mV Offset	±150 mV
pH calibration:	Up to 5 points
Conductivity Calibration:	1 point in each range
ATC :	Auto / manual 0,0 to 120°C
Input impedance:	>3x10 <sup>12</sup> ohms
Temperature sensor:	Thermistor, 10K ohms at 25°C
Memory:	When the unit is connected to a bluetooth device, the user can store data into the device that meets GLP requirements
pH electrode connection:	BNC
Conductivity cell connection:	6 PIN connector
Connectivity:	Bluetooth
Power requirement:	6 x 1,5 Volt AAA Alkaline batteries or AC adaptor
Dimensions (LxWxH):	210 x 150 x 45 mm
Weight (net):	approx. 430 g

## Code

## Description

BOE 5197700	Bench Top pH/mV/Ion/Temp Meter, Model MBT-700, AC adaptor, with standard accessories
-------------	--



Available Q4/2018 !



PH/TEMP. TESTER PT-70 WITH REPLACEABLE ELECTRODE

ELECTRODE MODULE

**PH/TEMP. POCKET TESTER PT-70**

with replaceable electrode

- ▶ Large display screen - displays pH and temperature at the same time
- ▶ 1, 2 or 3 point calibration, with automatic buffer recognition of US and NIST buffer sets
- ▶ Readings are automatically compensated for temperature (ATC)
- ▶ Electrode efficiency display
- ▶ Replaceable electrode module ensures extended usefulness
- ▶ IP67 water-tight housing
- ▶ Auto power off after 10 minutes of inactivity
- ▶ Battery life over 200 hours

**Specification:**

Modes:		pH, °C
Ranges:	pH	0 to 14 pH
	Temp.	-9,9...99,9 °C
Resolution:	pH	0,01 pH
	Temp.	0,1 °C
Accuracy:	pH	± 0,02 pH ± 1 digit
	Temp.	± 0,3 °C ± 1 digit
Temperature compensation:		Auto from -9,9 to 99,9°C
pH buffer recognition:		US (pH 4.01, 7,00 10,01) NIST (pH 4,00, 6,86, 9,18)
Buffer temp range:		0,0 - 60 °C
Input impedance:		> 10 <sup>12</sup> ohms
pH calibration:		1, 2 or 3 point calibration
pH electrode offset recognition:		±90mV at pH 7,00 ±98,3mV to -81,7mV at pH 6,86
pH electrode slope recognition:		±30% at pH 4,00; 4,01; 9,18 and 10,01
Power:		4 x LR44 bottom cell batteries
Dimensions :		193 x 44 x 25 mm
Weight :		105 grams (incl. batteries)

Code	Description
BOE 5190070	PH/Temp. Tester PT-70
BOE 5190071	Spare pH electrode module PT-70-1 for PT-70

**TECHNICAL BUFFER SOLUTIONS**

In square plastic bottles, PE, 500 ml, labeled with an individual batch no. on the bottles, traceable to SRM of NIST

Code	Description
BOE 104000	pH 4,00 (20°C), 500 ml
BOE 107000	pH 7,00 (20°C), 500 ml
BOE 110000	pH 10,00 (20°C), 500 ml
BOE 104004	pH 4,00 (20°C), 500 ml, red colour coded
BOE 107006	pH 7,00 (20°C), 500 ml, green colour coded
BOE 110008	pH 10,00 (20°C), 500 ml, blue colour coded

**CONDUCTIVITY CALIBRATION SOLUTIONS**

In square plastic bottles, PE, 250 ml, labeled with an individual batch no. on the bottles, traceable to PTB and NIST

Code	Description
BOE 300141	1,413 mS/cm KCL 0,01 mol/l (25°C), 250 ml
BOE 301288	12,88 mS/cm KCL 0,1 mol/l (25°C), 250 ml
BOE 311180	111,8 mS/cm KCL 1 mol/l (25°C), 250 ml

**ELECTROLYTE SOLUTION**

In square plastic bottles, PE, 500 ml, labeled with an individual batch no. on the bottles

Code	Description
BOE 400300	Potassium chloride 3 mol/l, 500 ml

## PH INDICATORS

pH-Fix is the most popular indicator stick for all purposes. The indicator dyes are chemically bound to the cellulose fibres, avoiding bleeding even in strong alkaline samples. Presentation: Box of 100 sticks 6 x 85 mm

Code	Description
M-N 92110	pH-Fix 0-14, pH Graduation 1,0

The budget priced universal indicator papers can be used for most standard applications. For each pH-value these papers show a single colour which can be matched with the colour scale at an interval of 1 pH-unit. Presentation: Reel of 5 m length and 7 mm width

Code	Description
M-N 90201	pH-Universal Indicator Paper, pH 1-11, pH Graduation 1,0
M-N 90204	pH-Universal Indicator Paper, pH 1-14, pH Graduation 1,0/2,0

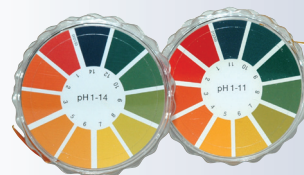

PH INDICATORS

## BOECO PORTABLE DO/TEMP. METER MODEL DO-580

- ▶ Simultaneous display of dissolved oxygen and temperature measurements
- ▶ Automatic temperature compensated (ATC) dissolved oxygen readings
- ▶ User selectable salinity and pressure compensated dissolved oxygen readings
- ▶ Works with accurate and reliable galvanic dissolved oxygen probes
- ▶ 50 data set reviewable memory
- ▶ Automatic shut off function (30 minutes of non-use)
- ▶ Battery life approx. 200-500 hours
- ▶ Low battery indicator
- ▶ IP65 waterproof case

### Specification:

#### Dissolved Oxygen (ppm)

Ranges	0,00 to 20,00 ppm (mg/L)
Resolution	0,01 ppm (mg/L)
Accuracy	±2 % of the reading or ±0,2 ppm

#### Dissolved Oxygen (%)

Ranges	0,0 to 200,0 %
Resolution	0,1 %
Accuracy	±2 % of the reading or ±0,2 air saturation

#### Temperature

Ranges	-6 to 46,0 °C
Resolution	0,1°C
Accuracy	±0,3 °C ±1 digit

Pressure compensation: 600 to 1100 mBar (450 to 825 mmHg)

Salinity compensation: From 0,0 to 40,0 ppt

Electrode type: Galvanic

Temperature sensor: Thermistor, 10K ohms, at 25 °C

Calibration backup: Yes

Automatic temp. comp: Yes

Power: 9 Volt battery

Size (LxWxD): 198x70x37 mm

Weight: 0,26 kg (1 x 9V Battery included)

The DO-580 will be delivered incl. the following standard accessories:  
1 x Watertight dissolved oxygen probe LD-900G-1, 1 x 30 ml Galvanic O<sub>2</sub> Fill Solution, 1 x 9 V battery, 1 x Operating manual, 1 x carrying case

Code	Description
BOE 5190580	Portable DO/Temperature Meter, Model DO-580 in carrying case with dissolved oxygen probe LD-900G-1



BOECO PORTABLE DO/TEMP METER MODEL DO-580







BOECO PORTABLE CONDUCTIVITY/  
TDS/SALINITY/TEMP METER  
MODEL CT-480



## BOECO PORTABLE CONDUCTIVITY/TDS SALINITY/TEMP. METER MODEL CT-480

- ▶ Simultaneous displays of conductivity, salinity or TDS with temperature measurements.
- ▶ Convenient one point calibration. Calibration data is stored in memory and is ready for use on power up.
- ▶ Adjustable TDS coefficient, reference temperature and temperature coefficient
- ▶ Uses one conductivity cell for conductivity, salinity and TDS measurement
- ▶ Accepts 4-wire conductivity cells with  $k=0,475$  cell constant and 2-wire  $K=0,1$  cell constant for improved flexibility and accuracy
- ▶ 50 data set reviewable memory
- ▶ Automatic shut off function (30 minutes of non-use)
- ▶ Battery life approx. 200 -500 hours
- ▶ Low battery indicator
- ▶ IP65 waterproof case

### Specification:

#### Conductivity K = 0,475

Range	Resolution	Accuracy
0,0 to 475 $\mu$ S/cm	0,1 $\mu$ S/cm	$\pm 1\%$ of reading +2 $\mu$ S/cm
475 to 4750 $\mu$ S/cm	1 $\mu$ S/cm	$\pm 1\%$ of reading +5 $\mu$ S/cm
4,75 to 47,50mS/cm	0,01mS/cm	$\pm 1\%$ of reading +0,05mS/cm
47,5 to 200,0mS/cm	0,1mS/cm	$\pm 2,5\%$ of reading +0,5mS/cm

#### Conductivity K = 0,1

Range	Resolution	Accuracy
0,00 to 99,99 $\mu$ S/cm	0,01 $\mu$ S/cm	$\pm 1\%$ of reading
100 to 200 $\mu$ S/cm	0,1 $\mu$ S/cm	$\pm 1\%$ of reading

#### Salinity

Range	Resolution	Accuracy
0,0 to 70,0 ppt	0,1 ppt	$\pm 0,2\%$ Full Scale

#### Temperature

Range	Resolution	Accuracy
-10,0 to 90,0 °C	0,1 °C	$\pm 0,2\%$ or $\pm 4\%$ Full Scale whichever is greater

Reference Temp.:	From 15,0 to 25,0°C, default is 25,0°C
Temperature Coefficient:	From 0,00 to 4,00 °C, default is 1,91°C
TDS Constant:	From 0,30 to 1,00, default is 0,65
Cell Constant	4 wire conductivity cell: $K = 0,475$
ATC	Thermistor, 10K ohms, at 25°C
Power	9 Volt battery
Size (LxWxD)	196x70x37 mm
Weight	0,26 kg (1 x 9V Battery included)

The CT-480 will be delivered incl. the following standard accessories:  
1 x 4-wire conductivity cell 3020P with  $k=0,475$   
1 x 9 V battery, 1 x operating manual, 1 x carrying case

Code	Description
BOE 5190480	Portable Conductivity/Salinity/TDS/Temperature Meter, Model CT-480 in carrying case with 4-wire Conductivity Cell 3020P with 6 PIN connector, $K=0,475$ (50 $\mu$ S - 200mS/cm)

#### Optional Conductivity Cell:

BOE 5190109	2-wire Conductivity Cell 109P with 6 PIN connector, $K=0,1$ (0,0 - 200,0 $\mu$ S/cm)
-------------	--

## BOECO BENCH TOP CONDUCTIVITY/ TDS/ SALINITY/TEMP. METER MODEL CT-676

- ▶ Simultaneous displays of conductivity, salinity or TDS with temperature measurements.
- ▶ Convenient one point calibration. Calibration data is stored in memory and is ready for use on power up.
- ▶ Adjustable TDS coefficient, reference temperature and temperature coefficient
- ▶ Uses one conductivity cell for conductivity, salinity and TDS measurement
- ▶ Accepts 4-wire conductivity cells with  $k=0,475$  cell constant and 2-wire  $K=0,1$  cell constant for improved flexibility and accuracy
- ▶ Low battery indicator
- ▶ IP54 waterproof case

### Specification:

#### Conductivity K = 0,475

Range	Resolution	Accuracy
0,0 to 475 $\mu$ S/cm	0,1 $\mu$ S/cm	$\pm 1\%$ of reading +2 $\mu$ S/cm
475 to 4750 $\mu$ S/cm	1 $\mu$ S/cm	$\pm 1\%$ of reading +5 $\mu$ S/cm
4,75 to 47,50mS/cm	0,01mS/cm	$\pm 1\%$ of reading +0,05mS/cm
47,5 to 200,0mS/cm	0,1mS/cm	$\pm 2,5\%$ of reading +0,5mS/cm

#### Conductivity K = 0,1

Range	Resolution	Accuracy
0.00 to 99,99 $\mu$ S/cm	0,01 $\mu$ S/cm	$\pm 1\%$ of reading
100 to 200 $\mu$ S/cm	0,1 $\mu$ S/cm	$\pm 1\%$ of reading

#### Salinity

Range	Resolution	Accuracy
0,0 to 70,0 ppt	0,1 ppt	$\pm 0,2\%$ Full Scale

#### Temperature

Range	Resolution	Accuracy
-10,0 to 90,0 $^{\circ}$ C	0,1 $^{\circ}$ C	$\pm 0,2\%$ or $\pm 4\%$ Full Scale whichever is greater

Reference Temp.:	From 15,0 to 25,0 $^{\circ}$ C, default is 25,0 $^{\circ}$ C
Temperature Coefficient:	From 0,00 to 4,00 $^{\circ}$ C, default is 1,91 $^{\circ}$ C
TDS Constant:	From 0,30 to 1,00, default is 0,65
Cell Constant	4 wire conductivity cell: K = 0,475
ATC	Thermistor, 10K ohms, at 25 $^{\circ}$ C
Power Requirement:	6 x 1,5 Volt AAA batteries or AC adaptor
Dimensions (LxWxH):	150 x 203 x 72 mm
Weight:	0,54 kg (6 x 1,5 V AAA Batteries included)

The CT-676 will be delivered incl. the following standard accessories:  
 1 x 4-wire conductivity cell 3020P with  $k=0,475$ , 6 x 1,5V AAA batteries,  
 1 x operating manual, 1 x flexible electrode holder

Code	Description
BOE 5196760	Bench Top Conductivity/Salinity/TDS/Temperature Meter, Model CT-676 with 4-wire Conductivity Cell 3020P with 6 PIN connector, $K=0,475$ (50 $\mu$ S - 200mS/cm), with EURO plug
BOE 5196761	Idem, with US plug AC adaptor

#### Optional Conductivity Cell:

BOE 5190109	2-wire Conductivity Cell 109P with 6 PIN connector, $K=0,1$ (0,0 - 200,0 $\mu$ S/cm)
-------------	--



CT-676



# CENTRIFUGES



**BOECO HAEMATOCRIT  
CENTRIFUGE HC-240**



Haematocrit rotor with lid as evaluation disc included.

capacity	75 µl
Capillaries	1,5 x 75 mm
	
Rotor and Lid as evaluation disc incl.	
Cat.-No.	—
capillaries per rotor	24
RCF	16,060
radius in mm	85
run-up in sec	9
run-down in sec <sup>2)</sup>	16

## BOECO HAEMATOCRIT CENTRIFUGE HC-240

High-speed bench-top centrifuge for haematocrit determinations with brushless frequency drive. At 16.060 g sedimentation is completed in just a little over 6 minutes.

The HC-240 centrifuge includes a segmented haematocrit rotor for 24 capillaries. With the segmented haematocrit rotor every capillary has its own chamber. If a capillary breaks, the fragments stay in this chamber or segment without affecting other capillaries.

The lid of the rotor is evaluation disc and cover in one. The haematocrit value can be read off the lid/evaluation disc right after centrifugation.

### Controls and displays

- ▶ During centrifugation the actual values of the parameters are indicated
- ▶ The centrifuge's speed and running time can be variably adjusted for different applications.
- ▶ Speed display in RPM or RCF  
RPM input from 200 to 10.000 in steps of 10, starting from 10.000 to the maximum speed in steps of 100  
RCF input from 200 to 10.000 in steps of 1, starting from 10.000 to the maximum speed in steps of 10
- ▶ Time t/min: 1 - 99 min. in steps of 1 min.,  
Time t/sec: 1 - 59 sec. in steps of 1 sec.,  
Continuous operation
- ▶ Brake stage, selectable between fast and slow
- ▶ Pulse key: For short centrifugation operations
- ▶ Open lid key

### Safety

- ▶ Lid locking and holding device
- ▶ Emergency lid lock release
- ▶ Lid closure of metal
- ▶ Imbalance switch-off
- ▶ Flexible motor bearings
- ▶ Deep metal rotor chamber (die-cast-aluminium) to securely accommodate the rotor

### Design

- ▶ Smooth plastic housing, easy to clean
- ▶ Metal lid
- ▶ Deep metal rotor chamber

### Technical details

Max. RPM (speed) / RCF:	13,000 rpm / 16,060 RCF
Noise level:	≤ 57 dB(A)
Dimensions in mm (HxWxD):	228 x 262 x 352
Net weight:	approx. 10 kg
Emission / Immunity :	EN / IEC 61326-1, class B / FCC class B

The HC-240 conforms to safety regulations such as IEC 61010, or the CE mark and all relevant EC standards and DIN norms and has been manufactured under ISO 9001:2008

### Code

### Description

BOE 01801-13	BOECO centrifuge HC-240, 208-240V, 50/60 Hz, with haematocrit rotor and lid as evaluation disc
BOE 01801-12	BOECO centrifuge HC-240, 100-127V, 50/60 Hz, with haematocrit rotor and lid as evaluation disc

## BOECO CENTRIFUGE SC-8

Practical and handy the SC-8 is the ideal centrifuge for small sample volumens. It is supplied with a 8-place angle steel rotor, which accomodates various tube systems as well as 15 ml glass tubes without adapters. The centrifuge is microprocessor controlled.

### Controls and displays

- ▶ During centrifugation the actual values of the parameters are indicated
- ▶ The centrifuge's speed and running time can be variably adjusted for different applications:
- ▶ Speed display in RPM or RCF
  - RPM input from 200 to the maximum speed in steps of 10
  - RCF input from 200 to the maximum speed in steps of 1
- ▶ Time t/min: 1 - 99 min. in steps of 1 min.,  
Time t/sec: 1 - 59 sec. in steps of 1 sec.,  
Continuous operation
- ▶ Brake stage, selectable between fast and slow
- ▶ Pulse key: For short centrifugation operations
- ▶ Open lid key

### Safety

- ▶ Lid locking and holding device
- ▶ Emergency lid lock release
- ▶ Lid closure of metal
- ▶ Imbalance switch-off
- ▶ Flexible motor bearings
- ▶ Deep metal rotor chamber (die-cast-aluminium) to securely accomodate the rotor

### Design







- ▶ Smooth plastic housing, easy to clean
- ▶ Metal lid
- ▶ Deep metal rotor chamber

The SC-8 conforms to safety regulations such as IEC 61010, or the CE mark and all relevant EC standards and DIN norms and has been manufactured under ISO 9001:2008

### Technical details

Max RPM (speed) / RCF:	6,000 rpm / 3,421 RCF
Noise level:	≤ 50 dB(A)
Dimensions in mm (HxWxD):	228 x 262 x 352
Net weight:	approx. 9 kg
Emission / Immunity:	EN / IEC 61326-1, class B / FCC class B

Code	Description
BOE 01800-13	BOECO centrifuge SC-8, 208-240 V, 50/60 Hz, complete with 8-place angle rotor
BOE 01800-12	BOECO centrifuge SC-8, 100-127 V, 50/60 Hz, complete with 8-place angle rotor

capacity in ml	4	5	7	15	15	blood collection / urine tubes
dimensions Ø x L mm	10 x 88	12/13 x 75	13 x 100	17 x 100	17 x 120	max 17 x 100
 n=6,000 min <sup>-1</sup> Rotor included						
Cat.-No.	06305	01054-A	01058	-	-	-
tubes per rotor	8	8	8	8	4	8
RCF	2,817	2,697	3,461	3,461	3,461	3,461
radius in mm	70	67	86	86	86	99
run-up in sec	17					
run-down in sec <sup>2)</sup>	37					



BOECO CENTRIFUGE SC-8





BOECO CENTRIFUGE SC-6



## BOECO CENTRIFUGE SC-6

The BOECO SC-6 is a small centrifuge with a swing-out rotor especially designed for use in clinical laboratories and medical practices.

It accepts common blood or urine tubes up to a volume of 15 ml and accelerates them to a maximum speed of 4,000 rpm<sup>-1</sup>

The BOECO SC-6 delivers optimal separation results and a horizontal layer of the separating gel that is identical to that achieved with a large centrifuge. Samples are therefore optimally prepared for analysis.

### Controls and displays

- ▶ During centrifugation the actual values of the parameters are indicated
- ▶ The centrifuge's speed and running time can be variably adjusted for different applications.
- ▶ Speed display in RPM x 100, input in steps of 100
- ▶ Time t/min: 1 - 99 min, continuous operation
- ▶ Pulse key: For short centrifugation operations
- ▶ Open lid key

### Safety

- ▶ Lid locking and holding device
- ▶ Centrifuge chamber of stainless steel
- ▶ Emergency lid lock release
- ▶ Lid closure of metal
- ▶ Imbalance switch-off
- ▶ Flexible motor bearings

### Design







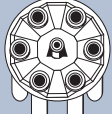

- ▶ Smooth plastic housing, easy to clean
- ▶ Metal lid
- ▶ Stainless steel centrifugation chamber, deep-drawn and seamless

The SC-6 conforms to safety regulations such as IEC 61010, or the CE mark and all relevant EC standards and DIN norms and has been manufactured under ISO 9001:2008

### Technical details

Max RPM (speed) / RCF:	4,000 rpm / 2,254 RCF
Noise level:	≤ 50 dB(A)
Dimensions in mm (HxWxD):	239 x 326 x 389
Net weight:	approx. 13 kg
Emission / Immunity:	EN / IEC 61326-1, class B / FCC class B

Code	Description
BOE 02300-13	BOECO centrifuge SC-6, 200-240V, 50/60 Hz, complete with 6-place swing-out rotor and carriers 02331 and 02333 (6 of each)
BOE 02300-12	BOECO centrifuge SC-6, 100-127V, 50/60 Hz, complete with 6-place swing-out rotor and carriers 02331 and 02333 (6 of each)

capacity in ml	4	5	6	1,6-7	4-7	8,5-10	15	blood collection / urine tubes
dimensions Ø x L mm	10 x 88	12x75	12x82	13/16x75	13x100	16x100	17x100	max 17 x 100
 n=4,000 min <sup>-1</sup> Rotor and carriers included								
Cat.-No.	02331	02333	02333	02333	02331	02331	02331	02331
tubes per rotor	6	6	6	6	6	6	6	6
RCF	2,254	1,807	1,807	1,807	2,254	2,254	2,254	2,254
radius in mm	126	101	101	101	126	126	126	126
run-up in sec	10							
run-down in sec <sup>2)</sup>	22							

## BOECO CENTRIFUGE C-28A

The non-refrigerated microprocessor-controlled C-28A is the ideal bench-top centrifuge for performing daily routine tasks in doctors' laboratories and small hospitals. But because of the wide range of accessories the C-28A can also be used for sample preparation in research and industrial laboratories.

The centrifuge has a brushless frequency drive (no carbon brushes). A special locking device allows effortless opening and closing of the lid with just one hand.

### Controls and displays

- ▶ During centrifugation the actual values of the parameters are indicated
- ▶ Entry of the running parameters via foil keypad
- ▶ Speed display in RPM x 100, input in steps of 100
- ▶ Time t/min: 1 - 99 min, continuous operation
- ▶ Impulse key: For short centrifugation operations

### Safety

















- ▶ Housing and lid of metal finished in a scratch and impact resistant coating
- ▶ Centrifuge chamber of stainless steel
- ▶ Lid locking and holding device
- ▶ See-through glass in the lid
- ▶ Emergency lid lock release
- ▶ Imbalance switch-off
- ▶ Easily exchangeable rotors
- ▶ Automatic rotor recognition

The C-28A conforms to safety regulations such as IEC 61010 or the CE mark and all relevant EC standards and DIN norms and has been manufactured under ISO 9001:2008

### Technical details

Max. RPM (speed) / RCF: 6,000 rpm / 4,226 RCF  
 Noise level: < 58 dB(A) (dependent on rotor)  
 Dimensions in mm: 257 (H) x 366 (W) x 430 (D)  
 Net weight: approx. 23 kg  
 Emission / Immunity: EN / IEC 61326-1 class B, FCC class B

Code	Description
BOE 01206-13	BOECO centrifuge C-28A, 208-240 V, 50-60 Hz, without rotor
BOE 01206-12	BOECO centrifuge C-28A, 100-127 V, 50-60 Hz, without rotor

capacity in ml	5	4-7	15	15	50	12	50	50
dimensions Ø x L mm	12 x 75	13 x 100	17 x 100	17 x 120	29 x 115	17 x 100	29 x 115	29 x 107
 n=4,000 min <sup>-1</sup> Cat.-No. 01418								
	+ 01054A 	+ 00716 	+ 00716 	+ E2109 	+ E2110 	+ 00716 	+ 00716 	+ 00716 
Cat.-No.	01467	01467	01467	01467	01468	01467	01468	01468
tubes per rotor	32	32	32	32	8	32	8	8
RCF	2,182	2,612	2,540	2,594	2,486	2,540	2,486	2,486
radius in mm	122	146	142	145	139	142	139	139
run-up in sec	36							
run-down in sec. <sup>2)</sup>	43							



BOECO CENTRIFUGE C-28A







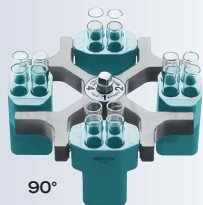







ROTOR 01418 WITH 01467

Swing-out rotor 01624,  
4-place, illustrated with  
carriers 01369  
n= 4,000 min<sup>-1</sup>,  
max RCF 2,665,  
max. cap. 4 x 100 ml.

































90°

capacity in ml	5	4-7	9	9	15	15	1,6 - 7	20	25	45	50
dimensions Ø x L mm	12/13x75	13x100	14x100	14x100	17x100	17x100	12/13x75 16 x 75	21x100	24x100	31x100	34x100
 n=4,000 min <sup>-1</sup> rotor Cat.-No. 01624											
Cat.-No.	01372	01739	01370	01741	01369	01742	01742	01346	01745	01345	01746
tubes per rotor	68	28	20	40	16	28	28	8	8	4	4
RCF	2,164	2,451	2,308	2,415	2,308	2,415	2,325	2,361	2,451	2,361	2,451
radius in mm	121	137	129	135	129	137	130	132	137	132	137
run-up in sec	22										
run-down in sec. <sup>2)</sup>	25										



Swing-out rotor, 4-place,  
01624 illustrated with  
carriers 01481 and lids  
01492 with bio-  
containment

capacity in ml	1	3	5/6/7	4-10	9/15	25	30	50	50	85	100	15	50	1,6 - 7	4 - 10
dimensions Ø x L mm	6 x 45 rhesus	10 x 60	12 x 75-100	16x75/100	14/17 x 100	24 x 100	26 x 95	29 x 107	34 x 100	38 x 106	44 x 100	17 x 120	29 x 115	13x75/100	16x75/100
lid with bio- containment 01492															
Carrier Cat.-No. 01481															
Cat.-No.	01339	01343	01383	01348	01329	01330	04417	04416	01331	01396	00761	01347	01384	01383	01348
tubes per rotor	108	36	20	16	16	4	4	4	4	4	4	4	4	20	16
RCF	2,594	2,630	2,558	2,522	2,540	2,433	2,451	2,630	2,415	2,612	2,558	2,665		2,558	2,522
radius in mm	145	147	143	141	142	136	137	147	135	146	143	149		143	141
run-up in sec	22														
run-down in sec. <sup>2)</sup>	25														

Please take care  
not to exceed the  
tubes' max.  
permissible RCF!













2) braked  
run-down



90°







































Swing-out rotor, 4-place 01324,  
illustrated with carrier 01398 and  
adapter 01483A

n= 4,000 min<sup>-1</sup>, max RCF 2,522

capacity ml	5-7	9	15	2,6-3,4	4-5,5	9-10	10	4-7	15	50	12	50
dimensions Ø x L mm	12x75/82/100	14x100	17x100	13x65	15x75	16x92	15x102	16 x 75	17x120	29x115	17x100	29x115
 Carrier Cat.-No. 01398												
Cat.-No.	01486	01482A	01486	01482A	01482A	01482A	01482A	01482A	01483A	01484	01482A	01484
tubes per rotor	20	16	20	16	16	16	16	16	16	4	16	4
RCF	2,486	2,522	2,486	2,272	2,522	2,397	2,612	2,576	2,522	2,576	2,522	2,576
radius in mm	139	141	139	127	141	134	146	144	144	141	144	
run-up in sec	27											
run-down in sec. <sup>2)</sup>	30											







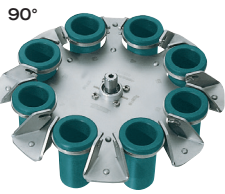



Swing-out rotor, 4-place 01324,  
illustrated with carrier 01490 and  
lids 01492  
n= 4,000 min<sup>-1</sup>, max RCF 2,630  
for max. 4 x 100 ml

capacity ml	1,5/2,0	1	3/4	5	6/7	9/15	25	50	100	10	30	50	85	15	50	12	25	30	50	
dimensions Ø x L mm	11 x 38	6 x 45 Rhesus	10x60/88	12x75	12x82/100	14/17x100	24 x 100	34 x 100	44 x 100	16x80/100	26x95	29x107	38x106	17x120	29x115	17x100	25 x90	25x110	29x115	
lid No. 01492 biocontainment <sup>2)</sup>																				
Carrier Cat.-No. 01490																				
Cat.-No.	01351	01339	01343	01383	01383	01329	01330	01331	00761	01348	04417	04416	01396	01356	01347	01384	06311	01363	01365	06318
tubes per rotor	20	108	36	20	20	16	4	4	4	16	4	4	4	12	4					
RCF	2,415	2,558	2,594	2,522	2,522	2,504	2,397	2,379	2,522	2,486	2,415	2,594	2,576	2,630			2,308	2,630		
radius in mm	135	143	145	141	141	140	134	133	141	139	135	145	144	147			129	147		
run-up in sec	27																			
run-down in sec. <sup>2)</sup>	30																			







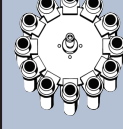

**Swing-out rotor, 8-place,**  
for 8 x 15 ml,  
n= 4,000 min<sup>-1</sup>, RCF 2,415  
Stainless steel, with  
suspensions No. 01644, PA,  
fibreglass reinforced.

capacity in ml	5	4-7	10	15
dimensions Ø x L mm	12/13x75	17 x 70	13 x 100	17 x 100
				
n=4,000 min <sup>-1</sup> Cat.-No. 01611				
Cat.-No.	01131-A	01132-A	01643	01644
tubes per rotor	8	8	8	8
RCF	1,914		2,415	
radius in mm	107		135	
run-up in sec	22			
run-down in sec. <sup>2)</sup>	25			







**Swing-out rotor, 12-place,**  
for 12 x 15 ml  
n= 4,000 min<sup>-1</sup>, RCF 2,680,  
Stainless steel, with  
suspensions No. 01621,  
PA, fibreglass reinforced.

capacity in ml	5	4-7	15
dimensions Ø x L mm	12/13 x 75	15/16 x 75	17 x 100
			
n=5,000 min <sup>-1</sup> Cat.-No. 01628			
Cat.-No.	01127-A	01122	01621
tubes per rotor	12	12	12
RCF	2,236	2,254	2,683
radius in mm	125	126	150
run-up in sec	22		
run-down in sec. <sup>2)</sup>	25		







**Swing-out rotor, 8-place,**  
for 8 x 50/15 ml Falcon  
tubes  
n= 4,000 min<sup>-1</sup>, RCF 2,469  
stainless steel, with  
suspensions, aluminium.

capacity in ml	15	50
dimensions Ø x L mm	17 x 120	29 x 115
		
n=4,000 min <sup>-1</sup> Cat.-No. 01617		
Cat.-No.	01462A	-
tubes per rotor	8	
RCF	2,469	
radius in mm	138	
run-up in sec	22	
run-down in sec. <sup>2)</sup>	25	

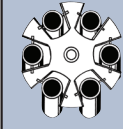

















**Swing-out rotor, 6-place,**  
for 6 x 50/15 ml Falcon  
tubes  
n= 4,000 min<sup>-1</sup>, RCF 2,701,  
Stainless steel, with  
suspensions, PA, fiber-  
glass reinforced.

capacity in ml	15	50
dimensions Ø x L mm	17 x 120	29 x 115
		
n=4,000 min <sup>-1</sup> Cat.-No. 01619		
Cat.-No.	01462-A	-
tubes per rotor	6	
RCF	2,701	
radius in mm	151	
run-up in sec	22	
run-down in sec. <sup>2)</sup>	25	











**Angle rotor, 6-place,**  
Cat. No. 01620A  
n= 6,000 min<sup>-1</sup>,  
max. RCF 4,226  
illustrated with adapter set  
01646

capacity in ml	10	15	30	50	50	85	15	50
dimensions Ø x L mm	16 x 80	17 x 100	26 x 95	29 x 107	34 x 100	38 x 106	17 x 120	29 x 115
								
n=6,000 min <sup>-1</sup> Cat.-No. 01620A								
Cat.-No.	01448	01451	01447	01446	01463	-	01466	01646
tubes per rotor	12	6	6	6	6	6	6	6
RCF	3,904	3,904	3,824	4,025	4,146	4,226	3,985	
radius in mm	97	97	95	100	103	105	99	
run-up in sec	19							
run-down in sec. <sup>2)</sup>	22							

4) Adapter set, 6-place, for conical 50 ml tubes with screw cap



**Angle rotor, 12-place,**  
Cat. No. 01613  
n= 6,000 min<sup>-1</sup>,  
max. RCF 4,146

capacity in ml	1,6-5	4-7	8,5-10	15	15
dimensions Ø x L mm	12/13 x 75	13 x 100	16 x 100	17 x 100	17 x 120
					
n=6,000 min <sup>-1</sup> Cat.-No. 01613					
Cat.-No.	01054-A	01058	-	-	-
tubes per rotor	12	12	12	12	6
RCF	3,300	4,146			
radius in mm	86	103			
run-up in sec	13				
run-down in sec. <sup>2)</sup>	15				

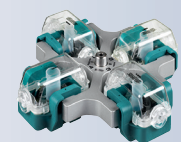

Cyto rotors, 4-place and 6-place suitable for C-28A more information is available in a detailed cyto brochure.

**2) Braked run down in sec.**

Please make sure not to exceed the tubes max. permissible RCF. For glass tubes the max. RCF is 4,000





**BOECO MINI  
CENTRIFUGE M-6**

## BOECO MINI CENTRIFUGE M-6

This Mini-centrifuge is ideal for quick spin downs for Micro and PCR tubes and PCR strip. The M-6 is supplied with a 6 x 1,5/2,0ml angle rotor, a 2 x 8 x 0,2ml strip rotor and a slide rotor.

Operation of the centrifuge begins when the lid is closed. When opening the lid the rotor automatically decelerates and comes to a stop.

A rubber footplate keeps the unit stable and avoids vibration.

The M-6 is CE marked and has been manufactured under ISO 9001

### Technical details

Max. RPM (speed) / RCF:	6,000 rpm / 2,000 x g
Noise level:	50 dB(A)
Power:	120V to 240V, 50/60Hz
Dimensions in mm:	175 (D) x 148 (W) x 118 (H)
Net weight:	approx 1,1 kg

Code	Description
BOE 8074000	BOECO Mini Centrifuge M-6, EU Plug
BOE 8074100	BOECO Mini Centrifuge M-6, US Plug
BOE 8074200	BOECO Mini Centrifuge M-6, UK Plug

## BOECO CENTRIFUGE MICROSPIN 12

is a compact bench-top microliter centrifuge for medical and biological research, molecular diagnostics, biochemistry, immunology and cell technologies. It can be used for extracting RNA/DNA samples, separation of cell suspensions and other micro quantitative analysis.

The microprocessor control provides precise control of the set parameters and a user-friendly interface allows a easy entry of parameters.

The brushless motor provides quite, vibration free performance, even at high speeds and a long product service life.

The angle rotor is made out of aluminium.

Due to the low voltage external power supply, the Microspin 12 can be used in cold rooms.

### Controls and displays

- ▶ During centrifugation the actual values of the parameters are indicated
- ▶ Entry of the running parameters via foil keypad
- ▶ Speed display in RPM x 100, increment 100 rpm
- ▶ Time t/min: 1 - 30 min, increment 1 min
- ▶ Open lid key

### Safety

- ▶ Lid locking and holding device
- ▶ Emergency lid lock release
- ▶ Metal protective inserts and enclosures inside the body
- ▶ See-through glass in the lid
- ▶ Imbalance switch-off

The Microspin 12 conforms to safety regulations such as EN 61326, EN 61010 or the CE mark and all relevant EC standards and DIN norms and has been manufactured under ISO 9001:2000

### Technical details

Max. RPM (speed) / RCF:	14,500 rpm / 12,400 x g
Noise level:	≤ 62 dB(A)
Power (external):	AC 100-240V, 60W/DC24V, 2.5A
Dimensions in mm:	200 (D) x 240 (W) x 125 (H)
Net weight:	approx. 3,5 kg

Code	Description
BOE 8075000	BOECO Micro centrifuge Microspin 12, 100-240V, 50/60 Hz, with angle rotor for 12 x 1,5 / 2,0 ml microtubes and spin columns. And each 12 adapters for 0,2 and 0,5 ml microtubes



**BOECO CENTRIFUGE MICROSPIN 12**

## BOECO CENTRIFUGE MC-24

Powerful, space-saving, low-noise, reliable and microprocessor-controlled microlitre centrifuge with brushless frequency drive.

### Controls and displays

- ▶ During centrifugation the actual values of the parameters are indicated
- ▶ Entry of the running parameters via foil keypad
- ▶ Speed display in RPM or RCF
  - RPM input from 200 to 10.000 in steps of 10, starting from 10.000 to the maximum speed in steps of 100
  - RCF input from 200 to 10.000 in steps of 1, starting from 10.000 to the maximum speed in steps of 10
- ▶ Time t/min: 1 - 99 min. in steps of 1min.,  
Time t/sec: 1-59 sec. in steps of 1 sec.,  
Continuous operation
- ▶ Brake stage, selectable between fast and slow
- ▶ Pulse key: For short centrifugation operations    ▶ Open lid key

### Safety

- ▶ Lid locking and holding device    ▶ Emergency lid lock release
- ▶ Motor overheating protection    ▶ Imbalance switch-off
- ▶ Deep metal rotor chamber (die-cast-zinc) to securely accommodate the rotor

The MC-24 conforms to safety regulations such as IEC 61010 or the CE mark and all relevant EC standards and DIN norms and has been manufactured under ISO 9001:2008

### Technical details

Max. RPM (speed) / RCF: 14,000 rpm / 18,845 RCF  
 Noise level: 59 dB(A)  
 Emission / Immunity: EN / IEC 61326-1 class B / FCC class B  
 Dimensions in mm: 228 (H) x 262 (W) x 352 (D)  
 Net weight: approx. 11 kg







BOECO CENTRIFUGE MC-24

NEW VERSION WITH 14.000 RPM  
 AVAILABALE IN Q3 / 2018

Code	Description
BOE 01203-13	BOECO centrifuge MC-24, 200-240 V, 50-60 Hz, without rotor
BOE 01203-12	BOECO centrifuge MC-24, 100-127 V, 50-60 Hz, without rotor





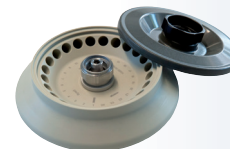

Angle rotor,  
 12-place  
 Cat. No. 01252-A  
 12-place,  
 n = 14,000 min<sup>-1</sup>,  
 max RCF 15,558

capacity in ml	1.5	0.5/0.8	0.2 /0.4	2.0
dimensions Ø x L mm	11x38	8x30/45	6x18/45	11x38
				
n = 14,000 min <sup>-1</sup> Cat.-No. 01252-A	with high speeds we recommend to use adapter No. 02031			
Cat.-No.	—	02023	02024	—
tubes per rotor	12			
RCF	15,558			
radius in mm	71			
run-up in sec.	15			
run-down in sec. <sup>2)</sup>	15			

45°







Angle rotor,  
 24-place,  
 Cat. No. 01226-A  
 n = 14,000 min<sup>-1</sup>,  
 max RCF 18,845

capacity in ml	1.5	0.5/0.8	0.2 /0.4	2.0
dimensions Ø x L mm	11x38	8x30/45	6x18/45	11x38
				
n = 14,000 min <sup>-1</sup> Cat.-No. 01226-A	with high speeds we recommend to use adapter No. 02031			
Cat.-No.	—	02023	02024	—
tubes per rotor	24			
RCF	18,845			
radius in mm	86			
run-up in sec.	15			
run-down in sec. <sup>2)</sup>	15			









Angle rotor,  
 18-place,  
 Cat. No. 01258-A  
 n = 14,000 min<sup>-1</sup>,  
 max RCF 16,654

capacity in ml	1.5	0.5/0.8	0.2 /0.4	2.0
dimensions Ø x L mm	11x38	8x30/45	6x18/45	11x38
				
n = 14,000 min <sup>-1</sup> Cat.-No. 01258-A	with high speeds we recommend to use adapter No. 02031			
Cat.-No.	—	02023	02024	—
tubes per rotor	18			
RCF	16,654			
radius in mm	76			
run-up in sec.	15			
run-down in sec. <sup>2)</sup>	15			



Angle rotor,  
 18-place,  
 Cat. No. 01213-A  
 n = 14,000 min<sup>-1</sup>,  
 max RCF 16,654

capacity in ml	1.5	0.5/0.8	0.2 /0.4	2.0	1.5	2.0
dimensions Ø x L mm	11x38	8x30/45	6x18/45	11x38	micro spin columns 11x38	
						
n = 14,000 min <sup>-1</sup> Cat.-No. 01213-A	with high speeds we recommend to use adapter No. 02031				with high speeds we recommend to use adapter No. 02031	
Cat.-No.	—	02023	02024	—	—	—
tubes per rotor	18					
RCF	16,654					
radius in mm	76					
run-up in sec.	16					
run-down in sec. <sup>2)</sup>	15					

The special raised rim of the rotor 01213-A enables centrifugation with open tube lids.



BOECO CENTRIFUGE M-240



BOECO CENTRIFUGE M-240R

## BOECO CENTRIFUGES M-240 / M-240R

The M-240 and M-240R rank among the fastest centrifuges in their class – With a maximum speed of 15,000 rpm and an RCF of 21,382 they are not only fast, the M-240R also refrigerates quickly: to +4°C with the Fast Cool function in 10 to 15 minutes..

Even thermosensitive samples can be gently centrifuged thanks to highly reliable refrigeration. Best separation results are guaranteed with the smooth-running, high-performance motor featuring a maintenance-free frequency drive. With the optional autoclavable and aerosol-tight accessories, even infectious materials can be processed safely for both the user and the environment.

### User-Friendliness

- ▶ Automatic lid locking
- ▶ Quick-entry foil keypad
- ▶ Easy-to-read, digital display
- ▶ Display of current parameter values
- ▶ Select key for parameter selection
- ▶ Impulse key for short centrifuging
- ▶ Open lid key
- ▶ RCF key
- ▶ Twist knob to enter values
- ▶ RPM in increments of 10
- ▶ Running time in minutes, max. 99 min
- ▶ Temperature in increments of 1°C (M-240R)
- ▶ 4 programmable memories

### Refrigeration (M-240R)

- ▶ Infinitely variable setting from –10 °C to +40 °C
- ▶ Fast Cool function in 10 - 15 min to +4 °C
- ▶ Stand-by mode maintains the set temperature
- ▶ Automatic refrigeration switch-off when the lid is opened

### Safety

- ▶ Lid dropping protection
- ▶ Lid locking and holding
- ▶ Emergency lid lock release
- ▶ Motor overheating protection
- ▶ Chamber overheating protection
- ▶ Imbalance switch-off
- ▶ Standstill indication

with the refrigerated model M-240R the LED in the Open key lights up with the M-240 the lid opens automatically after the rotor has come to a standstill

The M-240 / M-240R conform to safety regulations such as IEC 61010, all relevant EC standards and DIN norms and have been manufactured under ISO 9001:2008

### Technical details

	M-240	M-240R
Max. RPM (speed) / RCF:	15,000 RPM / 21,382 RCF	
Noise level: (dependent on rotor)	≤ 59 dB (A)	≤ 52 dB(A)
Dimensions in mm (HxWxD):	260 x 275 x 344	260 x 281 x 533
Net weight:	approx 11,5 kg	28 kg
Emission / Immunity:	EN / IEC 61326-1 / class B / FCC class B	







Code	Description
BOE 02400-13	BOECO centrifuge M-240, 200-240 V, 50-60 Hz, without rotor
BOE 02400-12	BOECO centrifuge M-240, 100-127 V, 50-60 Hz, without rotor
BOE 02405-13	BOECO refrigerated centrifuge M-240R, 200-240 V, 50 Hz, without rotor
BOE 02405-12	BOECO refrigerated centrifuge M-240R, 100-127 V, 50-60 Hz, without rotor

## Rotors for M-240 and M-240 R

40°





**Angle rotor, 24-place**  
**Cat. No. 02424B**  
 n= 15,000 min<sup>-1</sup>,  
 max RCF 21.382  
 Lid OE3243 incl.

capacity in ml	1.5	0.5/0.8	0,2 /0.4	2.0
dimensions Ø x L mm	11x38	8x30/45	6x18/45	11x38
 n=15,000 min <sup>-1</sup> Cat.-No. 02424B				
	with high speeds we recommend to use adapter No. 02031			
Cat.-No.	—	02023	02024	—
tubes per rotor	24			
RCF	21,382			
radius in mm	85			
run-up in sec.	20			
run-down in sec. <sup>2)</sup>	28			
temperature °C <sup>1)</sup>	+4			

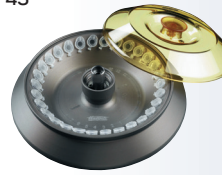
45°











**Angle rotor, 30-place,**  
**Cat. No. 02430B**  
 n= 15,000 min<sup>-1</sup>  
 max RCF 20.376  
 Lid OE3243 incl.

capacity in ml	0,5
dimensions Ø x L mm	8 x 30
 n=15,000 min <sup>-1</sup> Cat.-No. 02430B	
Cat.-No.	—
tubes per rotor	30
RCF	20,376
radius in mm	81
run-up in sec.	19
run-down in sec. <sup>2)</sup>	28
temperature °C <sup>1)</sup>	+4

45°



**Angle rotor, 24-place**  
**Cat. No. 02428**  
 n= 15,000 min<sup>-1</sup>,  
 max RCF 21,382  
 Lid with bio-containment,  
 autoclavable, phenol-re-  
 sistant incl.







capacity in ml	1.5	0.5/0.8	0,2 /0.4	2.0	1.5	2.0
dimensions Ø x L mm	11x38	8x30/45	6x18/45	11x38	micro spin columns 11x38	
 n=15,000 min <sup>-1</sup> Cat.-No. 02428						
	with high speeds we recommend to use adapter No. 02031					with high speeds we recommend to use adapter No. 02031
Cat.-No.	—	02023	02024	—	—	—
tubes per rotor	24					
RCF	21,382					
radius in mm	85					
run-up in sec.	20					
run-down in sec. <sup>2)</sup>	28					
temperature °C <sup>1)</sup>	+4					

The special raised rim of the rotor 02428 enables centrifugation of tubes with open lids. The rim supports the lids so they will not rip off during centrifugation. Centrifugation with open tube lids is performed for example when spinning tubes with filter elements, so called „spin columns“

52,5° inner /  
40° outer



**Angle rotor, 30-place,**  
**Cat. No. 02427A**  
 n= 15,000 min<sup>-1</sup>,  
 max RCF 20.627  
 Lid OE3243 incl.

capacity in ml	1.5	0.5/0.8	0,2 /0.4	2.0
dimensions Ø x L mm	11x38	8x30/45	6x18/45	11x38
 n=15,000 min <sup>-1</sup> Cat.-No. 02427A				
	with high speeds we recommend to use adapter No. 02031			
Cat.-No.	—	02023	02024	—
tubes per rotor	30			
RCF	20,627			
radius in mm	82			
run-up in sec.	22			
run-down in sec. <sup>2)</sup>	30			
temperature °C <sup>1)</sup>	+4			

Optional for rotor 02424B, 02430B, 02426B and 02427A

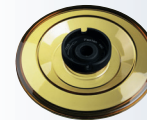

Lid (Cat. No. 02425)  
with bio-containment autoclavable

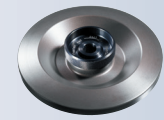



Lid (Cat. No. 02423)  
with bio-containment autoclavable, phenol-resistant

45°





**Angle rotor, 32-place, 4x 8**  
**for PCR tubes and strips**  
**Cat. No. 02418A**  
 n= 15,000 min<sup>-1</sup>  
 max RCF 14,338  
 Optional Lid OE3423

capacity in ml	0,2	
dimensions Ø x L mm	6 x 18	PCR strips
 n=15,000 min <sup>-1</sup> Cat.-No. 02418A		
Cat.-No.	—	
tubes per rotor	32	4 x 8
RCF	14,338	
radius in mm	57	
run-up in sec.	19	
run-down in sec. <sup>2)</sup>	28	
temperature °C <sup>1)</sup>	+4	

40°



**Angle rotor, 20-place**  
**for cryo tubes**  
**Cat. No. 02426B**  
 n= 15,000 min<sup>-1</sup>  
 max RCF 21,130  
 Lid OE3243 incl.

capacity in ml	1,8
dimensions Ø x L mm	cryo tubes
 n=15,000 min <sup>-1</sup> Cat.-No. 02426B	
Cat.-No.	—
tubes per rotor	20
RCF	21,130
radius in mm	84
run-up in sec.	19
run-down in sec. <sup>2)</sup>	28
temperature °C <sup>1)</sup>	+4



## BOECO CENTRIFUGES U-320 / U-320R

Because of their comprehensive range of accessories, the U-320 and U-320R centrifuges are the perfect universal centrifuges for routines in basic research and R&D laboratories of the pharmaceutical and biotechnical industry. The microprocessor controlled centrifuges have a brushless frequency drive (no carbon brushes) and a motorized lid locking.

### Performance

- ▶ High RCF
- ▶ Extremely short run-up and run-down times

### Design

- ▶ Metal housing, metal lid
- ▶ Stainless steel centrifugation chamber
- ▶ Viewing port in the lid

### Refrigeration (U-320R)

- ▶ Infinitely variable setting from  $-20\text{ }^{\circ}\text{C}$  to  $+40\text{ }^{\circ}\text{C}$
- ▶ Fast cool function

### User-Friendliness

- ▶ Automatic lid locking
- ▶ Easily exchangeable rotors
- ▶ 10 programmable memories
- ▶ 9 acceleration and braking ramps, or unbroken run down time

### Safety

- ▶ Lid locking and holding during rotor run
- ▶ Emergency lid lock release
- ▶ Motor overheating protection
- ▶ Chamber overheating protection (with U-320R)
- ▶ Imbalance switch-off
- ▶ Automatic rotor recognition
- ▶ Lid dropping protection

### Controls and displays

- ▶ During centrifugation the actual values of the parameters are indicated
- ▶ Change-over RPM/RCF: by entering the rotor radius  $r/\text{mm}$  the Centrifuge will calculate/indicate speed or RCF.
- ▶ Time preselection in steps of minutes and seconds / continuous operation
- ▶ Temperature  $T/^{\circ}\text{C}$ : Input in increments of  $1^{\circ}\text{C}$
- ▶ Impulse key: For short centrifugation operations

The U-320 / U-320R conform to safety regulations such as IEC 61010 or the CE mark and all relevant EC standards and DIN norms and have been manufactured under ISO 9001:2008

### Technical details

	U-320	U-320 R
Max. Capacity:	4 x 200 ml, 6 x 94 ml	
Max. RPM (speed) / RCF:	15,000 RPM / 21,382 RCF	
Noise level: (dependent on rotor)	$\leq 68\text{ dB (A)}$	$\leq 58\text{ dB(A)}$
Dimensions in mm (HxWxD):	346 x 395 x 520	346 x 401 x 695
Net weight:	approx 31 kg	53 kg
Emission / Immunity:	EN IEC 61326-1, class B / FCC Class B	

Code	Description
BOE 01401-13	BOECO centrifuge U-320, 200-240 V, 50-60 Hz, without rotor
BOE 01401-12	BOECO centrifuge U-320, 100-127 V, 50-60 Hz, without rotor
BOE 01406-13	BOECO refrigerated centrifuge U-320R, 200-240 V, 50 Hz / 240 V, 60 Hz, without rotor
BOE 01406-12	BOECO refrigerated centrifuge U-320R, 115-127 V, 60 Hz, without rotor



BOECO CENTRIFUGE U-320







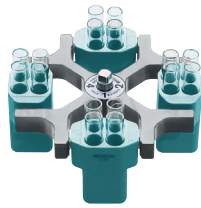

















































BOECO CENTRIFUGE U-320R

Swing-out rotor 01624,  
4-place, illustrated with  
carriers 01369  
n= 4,000 min<sup>-1</sup>,  
max. RCF 2,665  
max. cap. 4 x 100 ml.



Swing-out rotor,  
No. 01624, 4-place,  
n= 4,000 min<sup>-1</sup>,  
max. RCF 2,665  
for max. 4 x 100 ml

capacity in ml	5	4-7	9	9	15	1,6 - 7	15	20	25	45	50
dimensions Ø x L mm	12/13x75	13 x 100	14 x 100	14 x 100	17 x 100	12/13x75 16 x 75	17 x 100	21 x 100	24 x 100	31 x 100	34 x 100
											
n=4,000 min <sup>-1</sup> Cat.-No. 01624											
Cat.-No.	01372	01739	01370	01741	01369	01742	01742	01346	01745	01345	01746
tubes per rotor	68	28	20	40	16	28	28	8	8	4	4
RCF	2,164	2,451	2,308	2,415	2,308	2,325	2,415	2,361	2,451	2,361	2,451
radius in mm	121	137	129	135	129	130	137	132	137	132	137
run-up in sec	20	22		20		22		20			
run-down in sec. <sup>2)</sup>	25										
temperature °C <sup>1)</sup>		- 17		- 15	- 17	- 15	- 15	- 15	- 15	- 17	- 15

capacity in ml	1	3	1,6-7	4-10	9/15	25	30	50	50	85	100	15	50	1,6 - 7	4 - 10
dimensions Ø x L mm	6 x 45 Rhesus	10 x 60	13 x 75/100	16x75/100	14/17 x 100	24 x 100	26 x 95	29 x 107	34 x 100	38 x 106	44 x 100	17 x 120	29 x 115	13x75/100	16x75/100
															
lid 01492 Cat.-No. 01481															
Cat.-No.	01339	01343	01383	01348	01329	01330	04417	04416	01331	01396	00761	01347	01384	01383	01348
tubes per rotor	108	36	20	16	16	4	4	4	4	4	4	4	4	20	16
RCF	2,594	2,630	2,558	2,522	2,540	2,433	2,451	2,630	2,415	2,612	2,558	2,665	2,665	2,558	2,522
radius in mm	145	147	143	141	142	136	137	147	135	146	143	149	149	143	141
run-up in sec	20														
run-down in sec. <sup>2)</sup>	25														
temperature °C <sup>1)</sup>	- 15														











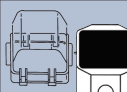

















1) Lowest attainable temperature in the U-320 R at max. speed.

2) braked run-down

Please take care not to exceed the tubes' max. permissible RCF!





























Swing-out rotor, No. 01494  
4-place,  
n= 5,000 min<sup>-1</sup>,  
max. RCF 4,193  
illustrated with buckets  
01427

capacity ml	1.5/2.0	1	3	5	6	7	9	15	25	50	15	25	30	50
dimensions Ø x L mm	11 x 38	6 x 45 Rhesus	10 x 60	13 x 75	12 x 82	12 x 100	14 x 100	17 x 100	24 x 100	34 x 100	17 x 120	25 x 90	25 x 110	29 x 115
														
lid 01421 Cat.-No. 01427														
Cat.-No.	05277	01357	01327	01732	05229	05230	05237	05231	05232	05233	05275	01731	05272	05276
tubes per rotor	36	120	48	32	48	48	24	24	8	4	4	8	4	4
RCF	4,109	4,081	4,053	4,025	4,053			3,941			4,165	3,969	4,025	4,053
radius in mm	147	146	145	144	145			141			149	142	144	145
run-up in sec	30													
run-down in sec. <sup>2)</sup>	32													
temperature °C <sup>1)</sup>	- 7													

3) When using these tubes, bucket 01427 cannot be closed with lid 01421



Swing-out rotor, No. 01494  
4-place,  
n= 5,000 min<sup>-1</sup>,  
max. RCF 4,193  
illustrated with buckets 01425

capacity ml	1.5/2.0	1	3	2,6-7	5/6/7	9/15	25	50	100	15	50	50	4 - 10
dimensions Ø x L mm	11 x 38	6 x 45 Rhesus	10 x 60	11x100	12x75-100	14/17x100	24 x 100	34 x 100	44 x 100	17 x 120	29 x 115	29 x 115	16x75/100
													
Cat.-No. 01425													
Cat.-No.	01444	01432	01433	01438	01434	01431	01435	01436	01437	01442	01443	01737	01441
tubes per rotor	36	144	56	28	48	28	8	4	4		4		28
RCF		3,969			3,913				3,801		4,081		3,913
radius in mm	139	142			140				136		146		140
run-up in sec	30												
run-down in sec. <sup>2)</sup>	32												
temperature °C <sup>1)</sup>	- 10												

capacity ml	1.5/2.0	1	3	5	6/7	9/15	25	50	100	10	30	50	85	15	50	12	25	30	50
dimensions Ø x L mm	11 x 38	6 x 45 Rheus	10x60	13x75	13x82/100	14/17x100	24 x 100	34 x 100	44 x 100	16x80/100	26x95	29x107	38x106	17x120	29x115	17x100	25 x90	25x110	29x115
lid No. 01492 biocontainment <sup>9)</sup>																			
Carrier Cat.-No. 01495																			
Cat.-No.	01351	01339	01343	01383	01383	01329	01330	01331	00761	01348	04417	04416	01396	01347	01384	06311	01363	01365	06318
tubes per rotor	20	108	36	20	20	16	4	4	4	16	4	4	4			4			
RCF	3,857	4,081	4,137	4,025	4,025	3,997	3,829	3,801	4,025	4,025	3,857	4,137	4,109		4,193		3,689		4,193
radius in mm	138	146	148	144	144	143	137	136	144	144	138	148	147		150		132		150
run-up in sec	30																		
run-down in sec. <sup>2)</sup>	32																		
temperature °C <sup>3)</sup>	-10																		



**Swing-out rotor 01324,**  
4-place, illustrated with  
suspension 01398 and  
adapter 01483  
n= 4,500 min<sup>-1</sup>,  
max. RCF 3,260



**Swing-out rotor 01324,**  
4-place, illustrated with  
carrier 01490 and lids  
01492  
n= 4,500 min<sup>-1</sup>,  
max. RCF 3,328  
for max. 4 x 100 ml

capacity ml	9	15	2,6-3,4	4-5,5	9-10	10	4-7	15	50	12	50
dimensions Ø x L mm	14x100	17x100	13x65	15x75	16x92	15x102	16 x 75	17x120	29x115	17x100	29x115
Carrier Cat.-No. 01398											
Cat.-No.	01482-A	01486	01482-A	01482-A	01482-A	01483-A	01484	01482-A	01484	01482-A	01484
tubes per rotor	16	20	16	16	16	16	16	16	4	16	4
RCF	3,192	3,147	2,875	3,192	3,034	3,305	3,260	3,192	3,260	3,192	3,260
radius in mm	141	139	127	141	134	146	144	141	144		
run-up in sec	27										
run-down in sec. <sup>2)</sup>	30										
temperature °C <sup>3)</sup>	-6										

capacity ml	1.5/2.0	1	3/4	5	6/7	9/15	25	50	100	4-10	30	50	85	15	50	12	25	30	50	
dimensions Ø x L mm	11 x 38	6 x 45 Rheus	10x60/88	12/13x75	13x82/100	14/17x100	24 x 100	34 x 100	44 x 100	16x75/100	26x95	29x107	38x106	17x120	29x115	17x100	25 x90	25x110	29x115	
lid No. 01492 biocontainment <sup>9)</sup>																				
Carrier Cat.-No. 01490																				
Cat.-No.	01351	01339	01343	01383	01383	01329	01330	01331	00761	01348	04417	04416	01396	01356	01347	01384	06311	01363	01365	06318
tubes per rotor	20	108	36	20	20	16	4	4	4	16	4	4	4	12		4				
RCF	3,056	3,237	3,283	3,192	3,192	3,170	3,034	3,011	3,192	3,147	3,056	3,283	3,260		3,328		2,920		3,328	
radius in mm	135	143	145	141	141	140	134	133	141	139	135	145	144		147		129		147	
run-up in sec	27																			
run-down in sec. <sup>2)</sup>	30																			
temperature °C <sup>3)</sup>	-6																			



**Swing-out rotor, 8-place,**  
n= 4,000 min<sup>-1</sup>,  
max. RCF 2,415,  
for 8 x 15 ml,  
stainless steel,  
with suspensions No.  
01644, PA, fibreglass  
reinforced.

capacity in ml	5	10	10	15
dimensions Ø x L mm	12/13x75	17 x 70	13 x 100	17 x 100
n=4,000 min <sup>-1</sup> Cat.-No. 01611				
Cat.-No.	01131-A	01132-A	01643	01644
tubes per rotor	8	8	8	8
RCF	1,914		2,415	
radius in mm	107		135	
run-up in sec	20			
run-down in sec. <sup>2)</sup>	20			
temperature °C <sup>3)</sup>	-16			



**Swing-out rotor, 12-place,**  
n= 5,000 min<sup>-1</sup>,  
max. RCF 4,193,  
for 12 x 15 ml, stainless  
steel, with suspensions  
No. 01621, PA, fibreglass  
reinforced.

capacity in ml	5	10	15
dimensions Ø x L mm	12/13 x 75	17 x 70	17 x 100
n=5,000 min <sup>-1</sup> Cat.-No. 01628			
Cat.-No.	01127-A	01122	01621
tubes per rotor	12	12	12
RCF	3,494	3,522	4,193
radius in mm	125	126	150
run-up in sec	16		
run-down in sec. <sup>2)</sup>	16		
temperature °C <sup>3)</sup>	-15		-10

capacity ml	1.5/2.0	5	5-7	1,6-7	9/15	25	50	85	100	125/150	200	30	50	15	50	12	25/30	50
dimensions Ø x L mm	11 x 38	17x59	12x75/100	13x75/100	14/17x100	24 x 100	34 x 100	38x101/6	44 x 100	51x100/116	56 x 112	26 x 95	29 x 107	17 x 120	29 x 115	17 x 100	25x90/110	29x115
lid No. 01561 biocontainment <sup>3)</sup>																		
Carrier Cat.-No 01560																		
Cat.-No.	01571	01593	01589	01589	01588	01573	01574	01575	01576	01594	-	01585	01586	01577	01595	01579	01582	01583
tubes per rotor	56	16	28	28	20	4	4	4	4	4	4	4	4	8	12	4	16	4
max. RCF	$\frac{3,328}{2,332}$	3,328	3,215	3,215	3,215	3,056	3,147	3,260	3,147	3,328	3,328	3,260	3,260	3,328			3,260	3,328
radius in mm	147/103	147	142	142	142	135	139	144	139	147	147	144	144	147			144	147
run-up in sec											28							
run-down in sec. <sup>2)</sup>											31							
temperature °C <sup>1)</sup>											- 8							



**Swing-out rotor, 01554, 4-place, illustrated with carrier 01560 and lids 01561**  
 n= 4,500 min<sup>-1</sup>,  
 max. RCF 3,328  
 for max. 4 x 200 ml

**Swing-out rotor, 01554, 4-place, illustrated with carrier 01563**

capacity in ml	12	15	50	50
dimensions Ø x L mm	17 x 100	17 x 120	29 x 115	29 x 115
Carrier Cat.-No. 01563				
Cat.-No.	01592	01592	-	-
tubes per rotor	8			
RCF	3,260			
radius in mm	144			
run-up in sec	28			
run-down in sec. <sup>2)</sup>	31			
temperature °C <sup>1)</sup>	- 8			



**Swing-out rotor, 6-place, n= 4,000 min<sup>-1</sup>, RCF 2,701, for 6 x 50/15ml Falcon tubes, stainless steel, with suspensions, PA, fiberglass reinforced.**

capacity in ml	15	50
dimensions Ø x L mm	17 x 120	29 x 115
Carrier Cat.-No. 01619		
Cat.-No.	01462-A	-
tubes per rotor	6	
RCF	2,701	
radius in mm	151	
run-up in sec	20	
run-down in sec. <sup>2)</sup>	22	
temperature °C <sup>1)</sup>	- 15	



**Swing-out rotor, 8-place, n= 5,000 min<sup>-1</sup>, RCF 3,857, for 8 x 50/15 ml, stainless steel, with suspensions, aluminium.**

capacity in ml	15	50
dimensions Ø x L mm	17 x 120	29 x 115
Carrier Cat.-No. 01617		
Cat.-No.	01462-A	-
tubes per rotor	8	
RCF	3,857	
radius in mm	138	
run-up in sec	20	
run-down in sec. <sup>2)</sup>	19	
temperature °C <sup>1)</sup>	- 10	



**Swing-out rotor, 4-place, n= 4,000 min<sup>-1</sup>, RCF 1,896, for microtitre plates, rotor and carriers No. 04345 of stainless steel.**

Carrier Cat.-No. 01645		microtitre plate	culture plate
Cat.-No.	04345		
plates per rotor	4		
RCF	1,896		
radius in mm	106		
run-up in sec	20		
run-down in sec. <sup>2)</sup>	19		
temperature °C <sup>1)</sup>	- 16		



**Swing-out rotor, 2-place, n=4,000 min<sup>-1</sup>, RCF 2,218 for microtitre plates, aluminium, coated, with suspensions No. 01453-A, stainless steel.**

Carrier Cat.-No. 01460		microtitre plate	culture plate	deep well plate	MS	QP	Microtest plate (Terasaki)	PCR plate 96 wells	PCR strips 0,2
Cat.-No.		01453-A						01453-A + 01485	
plates per rotor	10	8	6	2	2	2	4	2	24 x 8
RCF	2,218								
radius in mm	124								
run-up in sec	40								
run-down in sec. <sup>2)</sup>	45								
temperature °C <sup>1)</sup>	- 6								

**1) Lowest attainable temp. in precooled refrigerated centrifuges at max. speed.**







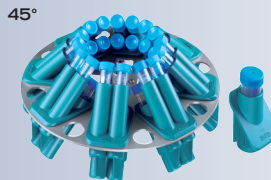

**2) Rund down in sec. braked**

**Please make sure not to exceed the tubes max. permissible RCF. For glass tubes the max. RCF is 4,000**





**Angle rotor,**  
**Cat. No. 01418**  
**8-place**  
**N = 4.500 min<sup>-1</sup>**  
**max. RCF 3,305**  
 illustrated with adapters  
**01467**

capacity in ml	4-7	15	15	50	12	50	50
dimensions Ø x L mm	13 x 100	17 x 100	17 x 120	29 x 115	17 x 100	29 x 115	29 x 107
							
n=4,500 min <sup>-1</sup> Cat.-No. 01418		+ 00716	+ E2109	+ E2110	+ 00716		
Cat.-No.	01467	01467	01467	01468	01467	01468	01468
tubes per rotor	32	32	32	8	32	8	8
RCF	3,305	3,215	3,283	3,147	3,215	3,147	3,147
radius in mm	146	142	145	139	142	139	139
run-up in sec	30						
run-down in sec. <sup>2)</sup>	31						
temperature °C <sup>1)</sup>	-11						











**4 Cyto rotors, suitable for U-320 and U-320R are available.**

**More informations are available in a detailed cyto brochure.**



**Angle rotor,**  
**Cat. No. 01620A**  
**6-place,**  
**n= 9,000 min<sup>-1</sup>,**  
**max. RCF 9,418.**  
 illustrated with adapter set  
**01646**

capacity in ml	10	15	30	50	50/75	85	15	50
dimensions Ø x L mm	16 x 80	17 x 100	26 x 95	29 x 107	34 x 100 35 x 105	38 x 106	17 x 120	29 x 115
								
n=9,000 min <sup>-1</sup> Cat.-No. 01620A								4)
Cat.-No.	01448	01451	01447	01446	01463	-	01466	01646
tubes per rotor	12	6	6	6	6	6	6	6
RCF	8,784	8,784	8,603	9,056	9,327	9,509	8,965	8,965
radius in mm	97	97	95	100	103	105	99	99
run-up in sec	30							
run-down in sec. <sup>2)</sup>	30							
temperature °C <sup>1)</sup>	- 11							

**1) Lowest attainable temp. in precooled refrigerated centrifuges at max. speed**





**2) Rund down in sec. braked**

**Please make sure not to exceed the tubes max. permissible RCF. for glass tubes the max. RCF is 4,000**

4) Adapter set, 6-place, for conical 50 ml tubes with screw cap







**Angle rotor,**  
**Cat. No. 01613**  
**12-place,**  
**n= 6,000 min<sup>-1</sup>,**  
**max. RCF 4,146**

capacity in ml	5	15	15
dimensions Ø x L mm	12/13 x 75	17 x 100	17 x 120
			
n=6,000 min <sup>-1</sup> Cat.-No. 01613			
Cat.-No.	01054A	-	-
tubes per rotor	12	12	6
RCF	3,300	4,146	
radius in mm	82	103	
run-up in sec	15		
run-down in sec. <sup>2)</sup>	15		
temperature °C <sup>1)</sup>	- 16		

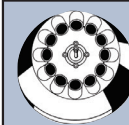



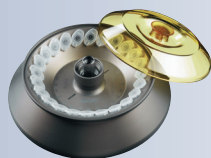

**Angle rotor,**  
**Cat. No. 01615**  
**12-place,**  
**n= 12,000 min<sup>-1</sup>,**  
**max. RCF 16,582**

capacity in ml	5	15	15
dimensions Ø x L mm	12/13x75	17 x 100	17 x 120
			
n=12,000 min <sup>-1</sup> Cat.-No. 01615			5)
Cat.-No.	01054A	-	01647
tubes per rotor	12	12	6
RCF	13,201	16,582	15,455
radius in mm	82	103	93
run-up in sec	40		
run-down in sec. <sup>2)</sup>	40		
temperature °C <sup>1)</sup>	-2		







**Angle rotor,**  
**Cat. No. 01420-B**  
**24-place,**  
**n= 15,000 min<sup>-1</sup>,**  
**max. RCF 21,382**

capacity in ml	1.5	0.5/0.8	0.2 /0.4	2.0
dimensions Ø x L mm	11x38	8x30/45	6x18/45	11x38
				
Lid 0E2040 incl. n=15,000 min <sup>-1</sup> Cat.-No. 01420-B				
Cat.-No.	-	02023	02024	-
tubes per rotor	24			
RCF	21,382			
radius in mm	85			
run-up in sec	25			
run-down in sec. <sup>2)</sup>	23			
temperature °C <sup>1)</sup>	-4			



**Angle rotor,**  
**Cat. No. 01689-A**  
**30-place,**  
**n= 14,000 min<sup>-1</sup>**  
**max RCF 21,255**

capacity in ml	1.5	0.5/0.8	0,2 /0,4	2.0
dimensions Ø x L mm	11x38	8x30/45	6x18/45	11x38
				
lid with bio-containment incl. n=14,000 min <sup>-1</sup> Cat.-No. 01689-A				
Cat.-No.	-	02023	02024	-
tubes per rotor	30			
RCF	21,255			
radius in mm	97			
run-up in sec	35			
run-down in sec. <sup>2)</sup>	31			
temperature °C <sup>1)</sup>	0			

Optional lids for rotor 01420B

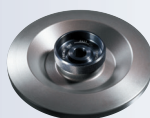

Lid (Cat. No. 02423 with bio-containment autoclavable, phenol-resistant



Lid Cat. No. 02425 with bio-containment autoclavable

5) Adapter set, 6-place, for conical 15 ml tubes with screw cap. Remove 6 opposite carriers from rotor 01615 and replace them with adapters 01647.